

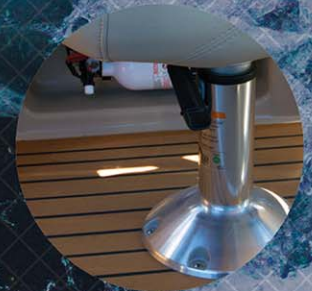

SPRINGFIELD MARINE COMPANY

# 2020

## MASTER CATALOG



# ABOUT SPRINGFIELD MARINE

**Springfield Aluminum Company** was founded in 1952 by Garnett Carnahan as an aluminum foundry and quickly found itself in a new emerging marine market that developed across the USA. By the late 1970's, the marine industry was the primary customer base that allowed SPRINGFIELD MARINE to develop as a brand of marine seating hardware. SPRINGFIELD MARINE has pioneered the marine seating industry with innovative designs that have allowed numerous patents and design acknowledgments that still hold the brand strong today. SPRINGFIELD MARINE continues to develop products to meet the growing needs of the marine industry while maintaining durability for safety, stability, and comfort.

**SPRINGFIELD MARINE COMPANY** has been doing business in China since 1990. Our state of the art facility in Jiangsu offers nearly 70,000 M<sup>2</sup> of in-house product designs, manufacturing, molding, and logistic services.

To ensure quality and customer satisfaction, we have continuously obtained the following authentications:

- Certificate of type approval of China Classification Society (CCS)
- DNV Business Assurance Management System Certificate (DNV)
- Type Approval Certificate (BV)
- EC Type-Examination Certificate
- ABYC H-31 Classifications (USA)

Our goal is to establish long term relationships to help grow and increase your market shares, as well as provide top of the line products that offer the comfort and safety your customers demand.

## WARRANTY INFORMATION



**HARDWARE: 5 Year Limited Warranty: Hardware (Pedestals, Mounts & Accessories)**

For a period of 5 years from the date of sale to the first use purchaser, SPRINGFIELD MARINE CO. will repair or replace, at our discretion, any product which proves to have manufacturer's defect in materials and workmanship under normal and proper usage.



**SEATING: 1 Year Limited Warranty: Upholstery & Cushions.**

(Upholstery & cushions) For a period of 1 year from the date of sale to the first use purchaser, SPRINGFIELD MARINE CO. will repair or replace, at our discretion, any upholstered product which proves to have manufacturer's defect involving vinyl, fabric, leather or foam components in materials and workmanship under normal and proper usage.



**SEATING: 5 Year Limited Warranty: Frame & Substrate.**

(Frame & substrate) For a period of 5 years from the date of sale to the first use purchaser, SPRINGFIELD MARINE CO. will repair or replace, at our discretion, any seating product which proves to have manufacturer's defect involving frame or substrate components in materials and workmanship under normal and proper usage.

THIS WARRANTY DOES NOT EXTEND TO CONSEQUENTIAL DAMAGES. (Some states do not allow the exclusion or limitation of incidental or consequential damages, so the above limitation or exclusion may not apply to you.)

The foregoing is the only warranty or representation made, express or implied, and specifically there is NO WARRANTY OF MERCHANTABILITY and NO WARRANTY OF FITNESS FOR A PARTICULAR PURPOSE.

SPRINGFIELD MARINE CO. is not liable for improper installation or improper use of the product or any failure or problems from lack of reasonable maintenance, racing activities, or commercial applications.

THIS WARRANTY SHALL BE CONSIDERED VOID IF, The seat or any accessory/equipment has been altered, modified, changed or reworked, subjected to abuse, neglect, or accident, including abnormal use, the seat is installed in a manner that would subject the seat to abnormal use. THIS WARRANTY IS VOID IF MIXING SPRINGFIELD MARINE COMPONENTS WITH NON-SPRINGFIELD MARINE PARTS.

In order to obtain service under the warranty, the customer must notify our customer service department to obtain a return authorization. Phone: (417) 725-2667

## PROPOSITION 65 CALIFORNIA



**SPRINGFIELD MARINE CO.**

Attn: Returns (Your RA#)

1093 N. Cynthia Drive

Nixa, Mo 65714

Our dealers and distributors are not authorized to modify the warranty in any respect.

SPRINGFIELD MARINE's continuing program of product development and improvement makes specifications, colors, standard features, designs, prices and availability subject to change without notice or obligation. See your Springfield Marine dealer for current information.

These products are not designed or warranted for racing or high performance use.

NOTE: COMMERCIAL USE RESTRICTIONS APPLY, CONTACT US FOR DETAILS.

Customers are responsible for paying return freight as well as the freight on a new order if you are making an exchange. Springfield Marine is not responsible for lost items in return shipping so please insure your package.

# Product Catalog

## Table of Contents

**Seating** ..... 5 - 31  
FOLDING SEATS • STAND-UP SEATS • MOLDED SEATS • UPHOLSTERED SEATS • HELM SEATS

**KingPin™** ..... 32 - 39  
PACKAGES • SEAT MOUNTS • POSTS • BASES • ACCESSORIES

**Taper-Lock™** ..... 40 - 44  
PACKAGES • SEAT MOUNTS • POSTS • BASES • ACCESSORIES

**Plug-In™** ..... 45 - 50  
PACKAGES • SEAT MOUNTS • POSTS • BASES • ACCESSORIES

**Thread-Lock™** ..... 51 - 53  
PACKAGES • SEAT MOUNTS • POSTS • BASES • ACCESSORIES

**Spring-Lock™ & Clip-Lock** ..... 54 - 59  
PACKAGES • SEAT MOUNTS • POSTS • BASES • ACCESSORIES

**2-3/8" Series** ..... 60 - 65  
PEDESTAL PACKAGES • SLIDES & SWIVELS • PEDESTALS

**2-7/8" Series** ..... 66 - 74  
PEDESTAL PACKAGES • SLIDES & SWIVELS • PEDESTALS

**4" Series** ..... 75 - 80  
PEDESTAL PACKAGES • SLIDES & SWIVELS • PEDESTALS

**Mounting Systems** ..... 81 - 88  
MOUNTING SLIDES • MOUNTING SWIVELS • MOUNTING RAILS • MOUNTING POSTS

**Barbecue Tables & Grills** ..... 89 - 100  
BARBECUE GRILLS • TABLE PACKAGES • TABLE TOPS • MOUNTS • POSTS • BASES

**Accessories** ..... 101 - 111  
ARMRESTS • FOOTRESTS • DECK PLATES • SKI TOWS • MOTOR MOUNTS

- Seating System
- Kingpin™
- Taper-Lock™
- Plug-In™
- Thread-Lock™
- Spring-Lock™
- 2-3/8" Series
- 2-7/8" Series
- 4" Series
- Mounting Systems
- Barbecue Tables & Grills
- Accessories
- Part Number Index

Please note that the actual products may differ slightly from specifications and/or the pictures contained in our catalog, web site, viewing areas or order forms. Thus, Springfield Marine is not responsible for typographical, pricing, product information, advertising or shipping errors.

## ABOUT SEATING

Springfield Marine knows that comfort is important in marine seating. Whether behind the wheel for long passages in rough water, dropping a line in a quiet creek, or anywhere in between. Springfield Marine offers a wide range of configurations and options.

Quality, comfort, and strength add up to value, and value is an important consideration in choosing the best seating system that's right for you. Our wide variety of chairs and even greater choice of seating hardware provide an array of combinations second to none.

Matching the chair with the correct seating hardware is also an important consideration in product selection. So whether selecting one of our seating packages or making your own combinations, Springfield Marine offers the right product to meet a wide range of needs.

*Custom Seating and Upholstrey available upon request for OEM production.*



FOLDING SEAT

FOLDING SEATS • STAND-UP SEATS • MOLDED SEATS • UPHOLSTERED SEATS • HELM SEATS



Center Pivot Point  
(No Hinge)

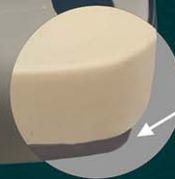

Plastic injected  
molded frame



Includes mounting  
hardware



Premium UV stable  
vinyl

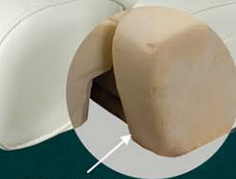

High density  
molded foam

## FISH PRO 1

IMAGE	PART NUMBER	DESCRIPTION	PACK QUANTITY
A.	1041606-1	FISH PRO I, SEAT - WHITE	1 PACK
B.	1041631-1	FISH PRO I, SEAT - GRAY/BLUE	1 PACK
C.	1041634-1	FISH PRO I, SEAT - CHAR/GRAY	1 PACK
D.	1041684-1	FISH PRO I, SEAT - CHAR/TAN	1 PACK



Premium upholstery and cushions are designed to provide maximum comfort and quality. Backrest is fitted with ergonomically molded cushions and extended sides for extra support. Durable injection molded shell with center Pivot Point allows seat to fold down flat.

- Weather resistant marine grade vinyl
- Universal mounting pattern 5"x12"
- Grandeur Vinyl
- Molded in seat grab inserts
- Channel for optional armrests
- Concealed pinch proof center pivot point



Folded Position

## FISH PRO 1 MID BACK

IMAGE	PART NUMBER	DESCRIPTION	PACK QUANTITY
A.	1041636	FISH PRO MID BACK, FOLDING SEAT - WHITE	1 PACK
B.	1041733	FISH PRO MID BACK, FOLDING SEAT - CHARCOAL & GRAY	1 PACK



Contour lumbar cushion cradles your back for maximum support. Designed for style, comfort, and durability. Deep mesh pocket on back of seat.

- Folds down easily
- Concealed pinch proof center pivot point
- Weather resistant marine grade vinyl
- Universal mounting pattern: 5" x 5" & 5" x 12"
- Grandeur vinyl



Folded Position

## SUBSTRATE & FOAM FISH PRO 1

OEM IMAGE	PART NUMBER	DESCRIPTION	PACK QUANTITY
A.	1041600-SF1	FISH PRO 1 - SUBSTRATE & FOAM	1 PACK

Plastic injected substrate with support ribbing and metal inserts for support.

- Molded in T-nuts
- Molded Foam
- Concealed pinch proof center pivot point
- Channel for optional armrests



BACK



BOTTOM

## FISH PRO II HIGH BACK



IMAGE	PART NUMBER	DESCRIPTION	PACK QUANTITY
A.	1041419	FISH PRO II HIGH-BACK - NAVY & GRAY	1 PACK
B.	1041483	FISH PRO II HIGH-BACK - CHAR & GRAY	1 PACK
C.	1080013-G	OPTIONAL ARMREST	1 PACK

Premium upholstery and cushions are designed to provide maximum comfort and quality. Backrest is fitted with ergonomically molded cushions and extended sides for extra support. Durable injection molded shell with center pivot point allows seat to fold down flat.

- High Back - Folds down easily
- Weather resistant marine grade vinyl
- Universal mounting pattern 5" x 12"
- Sorrento Vinyl
- Molded in seat grab inserts
- Channel for optional armrests



## FISH PRO II LOW BACK



IMAGE	PART NUMBER	DESCRIPTION	PACK QUANTITY
A.	1041519	FISH PRO II, LOW-BACK - NAVY & GRAY	1 PACK
B.	1041583	FISH PRO II, LOW-BACK - CHAR & GRAY	1 PACK

Premium upholstery and cushions are designed to provide maximum comfort and quality. Backrest is fitted with ergonomically molded cushions and extended sides for extra support. Durable injection molded shell with center pivot point allows seat to fold down flat.

- Low Back - Folds down easily
- Weather resistant marine grade vinyl
- Universal mounting pattern 5" x 12"
- Sorrento Vinyl
- Molded in seat grab inserts
- Channel for optional armrests



## SUBSTRATE & FOAM FISH PRO II



OEM IMAGE	PART NUMBER	DESCRIPTION	PACK QUANTITY
A.	1041800-SF	FISH PRO II, HIGH-BACK - SUBSTRATE & FOAM	1 PACK
B.	1041900-SF	FISH PRO II, LOW-BACK - SUBSTRATE & FOAM	1 PACK

Plastic injected substrate with support ribbing and metal inserts for support. Concealed pinch proof center pivot point.

- Molded in T-nuts
- Molded Foam
- Secondary plastic inserts for upholstery fasteners
- Channel for optional armrests



## SKIPPER PREMIUM HIGH BACK

FOLDING SEATS



IMAGE	PART NUMBER	DESCRIPTION	PACK QUANTITY
A.	1061063-B	SKIPPER PREMIUM HIGH BACK, FOLDING SEAT - CHAR/GRAY	1 PACK
B.	1061069-B	SKIPPER PREMIUM HIGH BACK, FOLDING SEAT - BLUE/GRAY	1 PACK

Contour Lumbar Cushion Cradles Your Back For Maximum Support. Designed For Style, Comfort And Durability. Folds Down Easily.

- Injected plastic frame
- Folds down easily
- T-nuts installed into seat for better mounting durability
- Universal Mounting Pattern: 5" x 5"
- Sorrento/Heritage Vinyl



## SKIPPER PREMIUM LOW BACK



IMAGE	PART NUMBER	DESCRIPTION	PACK QUANTITY
A.	1061077-1	SKIPPER PREMIUM LOW BACK, FOLDING SEAT - GRAY/BLACK	1 PACK
B.	1061079-1	SKIPPER PREMIUM LOW BACK, FOLDING SEAT - GRAY/BLUE	1 PACK

Injection molded seats with interlocking hinge for greater structural support. Extra wide seat with high quality synthetic boat fabric for all day comfort.

- Black Plastic Frame
- Folds down easily
- T-nuts installed into seat for better mounting durability
- Universal Mounting Pattern: 5" x 5"
- Grandeur/Imperial Vinyl



## SKIPPER DELUXE



IMAGE	PART NUMBER	DESCRIPTION	PACK QUANTITY
A.	1061057	SKIPPER, GRAY SKIPPER DELUXE WI CHAR & GRAY CUSHIONS	1 PACK
B.	1061072	SKIPPER OEM DELUXE WI CHAR & GRAY CUSHIONS	1 PACK

Injection molded seats with interlocking hinge for greater structural support. Extra wide seat with high quality synthetic boat fabric for all day comfort.

- Folds down easily
- Universal mounting pattern: 5"x5"
- T-nuts installed into seats for better mounting durability
- Snap on cushion



# Seating

FOLDING SEATS

## SKIPPER STANDARD

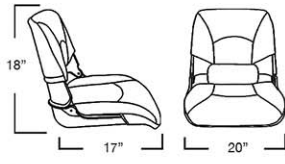

Seat Dimensions

IMAGE	PART NUMBER	DESCRIPTION	PACK QUANTITY
A.	1061016	SKIPPER, WHITE SHELL W/ WHITE & BLUE CUSHIONS	1 PACK
B.	1061017	SKIPPER, GRAY SHELL W/ GRAY & CHAR CUSHIONS	1 PACK
C.	1061018	SKIPPER, GRAY SHELL W/ GRAY & RED CUSHIONS	1 PACK
D.	1061019	SKIPPER, GRAY SHELL W/ GRAY & BLUE CUSHIONS	1 PACK
E.	1061025	SKIPPER, WHITE SHELL W/ WHITE CUSHIONS	1 PACK

Injection molded seats with interlocking hinge for greater structural support. Extra wide seat with high quality upholstery for all day comfort.

- 5" x 5" & 5" x 12" Bolt Pattern
- Snap on cushions



## SKIPPER CAMO

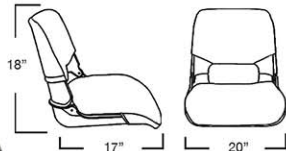

Seat Dimensions

IMAGE	PART NUMBER	DESCRIPTION	PACK QUANTITY
A.	1061020	SKIPPER, BLACK SHELL W/ MOSSY OAK™ BREAK UP CUSHIONS	1 PACK
B.	1061021	SKIPPER, BLACK SHELL W/ MOSSY OAK™ DUCK BLIND CUSHIONS	1 PACK

Injection molded seats with interlocking hinge for greater structural support. Extra wide seat with premium high quality camouflage upholstery.

- 5" x 5" & 5" x 12" Bolt Pattern
- Black plastic shell



Folded Position

## SKIPPER SHELLS

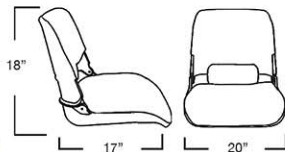

Seat Dimensions

IMAGE	PART NUMBER	DESCRIPTION	PACK QUANTITY
A.	1061015-S	SKIPPER, FOLD DOWN SHELL - GRAY	1 PACK
B.	1061015-SB	SKIPPER, FOLD DOWN SHELL - BLACK	1 PACK
C.	1061015-SW	SKIPPER, FOLD DOWN SHELL - WHITE	1 PACK
A.	1061015-M	SKIPPER, FOLD DOWN SHELL - GRAY	10 PACK BULK
B.	1061015-MB	SKIPPER, FOLD DOWN SHELL - BLACK	10 PACK BULK
D.	1061015-MS	SKIPPER, FOLD DOWN SHELL - SAND	10 PACK BULK

Injection molded seats with interlocking hinge for greater structural support.

- 5" x 5" & 5" x 12" Bolt Pattern
- T-Nuts



Folded Position



## TRAVELER MULTI COLOR



IMAGE	PART NUMBER	DESCRIPTION	PACK QUANTITY
A.	1061121-C	TRAVELER, GRAY SHELL W/ BLUE & GRAY CUSHIONS	2 PACK
B.	1061123-C	TRAVELER, GRAY SHELL W/ CHAR & GRAY CUSHIONS	2 PACK
C.	1061115-C	TRAVELER, WHITE SHELL W/ BLUE CUSHIONS	2 PACK

Super strong copolymer frame with extra wide contoured seat and curved back.

- Durable strap holds seat closed when folded down
- Universal mounting pattern: 5.25" x 5.25"



## TRAVELER STANDARD



IMAGE	PART NUMBER	DESCRIPTION	PACK QUANTITY
A.	1061100-C	TRAVELER, GRAY SHELL W/ GRAY CUSHIONS	2 PACK
B.	1061103-C	TRAVELER, BLACK SHELL W/ BLACK CUSHIONS	2 PACK
C.	1061104-C	TRAVELER, WHITE SHELL W/ WHITE CUSHIONS	2 PACK
D.	1061105-C	TRAVELER, GREEN SHELL W/ GREEN CUSHIONS	2 PACK
E.	1061112-C	TRAVELER, GRAY SHELL W/ BLUE CUSHIONS	2 PACK
F.	1061113-C	TRAVELER, GRAY SHELL W/ CHARCOAL CUSHIONS	2 PACK
G.	1061114-C	TRAVELER, GRAY SHELL W/ RED CUSHIONS	2 PACK



## TRAVELER CAMO



IMAGE	PART NUMBER	DESCRIPTION	PACK QUANTITY
A.	1061106-C	TRAVELER, GREEN SHELL W/ MOSSY OAK™ BREAK-UP CUSHIONS	2 PACK
B.	1061107-C	TRAVELER, GREEN SHELL W/ MOSSY OAK™ DUCK BLIND CUSHIONS	2 PACK
C.	1061108-C	TRAVELER, BROWN SHELL W/ MOSSY OAK™ DUCK BLIND CUSHIONS	2 PACK



## TRAVELER SHELLS



IMAGE	PART NUMBER	DESCRIPTION	PACK QUANTITY
A.	1061100-S	TRAVELER, FOLD DOWN SHELL - GRAY	2 PACK
C.	1061104-S	TRAVELER, FOLD DOWN SHELL - WHITE	2 PACK
D.	1061105-S	TRAVELER, FOLD DOWN SHELL - GREEN	2 PACK



# Seating

FOLDING SEATS

## OEM FOLDING

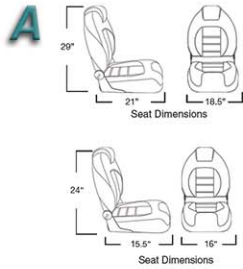

IMAGE	PART NUMBER	DESCRIPTION	PACK QUANTITY
A.	1062583	OEM SERIES, FOLDING SEAT - CHARCOAL & TAN	1 PACK
B.	1062683	OEM MEDIUM SERIES, FOLDING SEAT - CHARCOAL & TAN	1 PACK

Premium high quality upholstery and cushions with rigid injection molded frame.

- Folds down easily
- Heavy-duty pinchless hinges
- Weather resistant marine grade vinyl
- Mounting Pattern 5x5 & 5x12



## HIGH BACK PREMIUM PINCHLESS

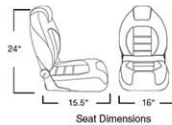

IMAGE	PART NUMBER	DESCRIPTION	PACK QUANTITY
A.	1062025-01	PREMIUM PINCHLESS SEAT - CHARCOAL & GRAY	1 PACK

Premium high quality upholstery and cushions with rigid injection molded frame.

- Folds down easily
- Heavy-duty pinchless hinges
- Weather resistant marine grade vinyl
- Mounting Pattern 5x5 & 5x12
- Double Stitch



## SPORT FOLDING

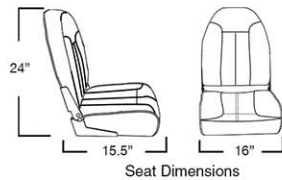

IMAGE	PART NUMBER	DESCRIPTION	PACK QUANTITY
A.	1040513	SPORT FOLDING SEAT, BLUE & GRAY	1 PACK
B.	1040543	SPORT FOLDING SEAT, GRAY & CHAR	1 PACK

Premium high quality upholstery and cushions with rigid injection molded frame.

- Folds down easily
- Heavy-duty pinchless hinges
- Weather resistant marine grade vinyl
- Mounting Pattern 5x5 & 5x12
- Double Stitch



## HIGH BACK MULTI COLOR



IMAGE	PART NUMBER	DESCRIPTION	PACK QUANTITY
A.	1040661	HIGH BACK, ECONOMY FOLDING SEAT - GRAY & BLUE	1 PACK
B.	1040663	HIGH BACK, ECONOMY FOLDING SEAT - GRAY & CHARCOAL	1 PACK
C.	1040665	HIGH BACK, ECONOMY FOLDING SEAT - GRAY & RED	1 PACK
D.	1040667	HIGH BACK, ECONOMY FOLDING SEAT - WHITE & BLUE	1 PACK
E.	1040668	HIGH BACK, ECONOMY FOLDING SEAT - SAND & BROWN	1 PACK

- Strap on back for secure seat fastening
- Folds down easily
- Weather resistant marine grade vinyl
- Pinchless hinges
- Universal mounting pattern: 5" x 5" & 5" x 12" Bolt Pattern



## HIGH BACK STANDARD



IMAGE	PART NUMBER	DESCRIPTION	PACK QUANTITY
A.	1040649	HIGH BACK, ECONOMY FOLDING SEAT - WHITE	1 PACK
B.	1040643	HIGH BACK, ECONOMY FOLDING SEAT - GRAY	1 PACK

- Strap on back for secure seat fastening
- Folds down easily
- Weather resistant marine grade vinyl
- Pinchless hinges
- Universal mounting Pattern: 5" x 5" & 5" x 12" Bolt Pattern



## HIGH BACK CAMO



IMAGE	PART NUMBER	DESCRIPTION	PACK QUANTITY
A.	1040647	HIGH BACK, FOLDING SEAT - MOSSY OAK™ DUCK BLIND	1 PACK
B.	1040646	HIGH BACK, FOLDING SEAT - MOSSY OAK™ BREAK-UP	1 PACK

- Strap on back for secure seat fastening
- Folds down easily
- Weather resistant marine grade vinyl
- Pinchless hinges
- Universal mounting pattern: 5" x 5" & 5" x 12" Bolt Pattern



## PREMIUM WAVE



IMAGE	PART NUMBER	DESCRIPTION	PACK QUANTITY
A.	1062031	PREMIUM FOLDING - GRAY W/ BLUE & METEOR STRIPE	1 PACK
B.	1062034	PREMIUM FOLDING - GRAY W/ METEOR STRIPE	1 PACK

Premium high quality upholstery and cushions with rigid injection molded frame for maximum support and comfort. Durable strap with snap keeps seat closed when folded down. 5" x 5" & 5" x 12" Bolt Pattern.



# Seating

FOLDING SEATS

## ECONOMY MULTI COLOR

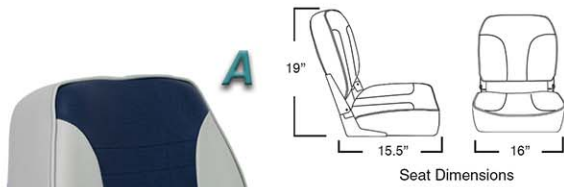

IMAGE	PART NUMBER	DESCRIPTION	PACK QUANTITY
A.	1040651	ECONOMY, FOLDING SEAT - GRAY & BLUE	1 PACK
B.	1040653	ECONOMY, FOLDING SEAT - GRAY & CHARCOAL	1 PACK
C.	1040655	ECONOMY, FOLDING SEAT - GRAY & RED	1 PACK

Comfortable cushioned seat to support your backside. Strap with snap to keep seat secure when folded down. Rigid injection molded frame.

- Folds down easily
- Heavy-duty powder coated hinges
- Universal mounting pattern: 5" x 5"



## ECONOMY STANDARD



IMAGE	PART NUMBER	DESCRIPTION	PACK QUANTITY
A.	1040621	ECONOMY, FOLDING SEAT - BLUE	1 PACK
B.	1040622	ECONOMY, FOLDING SEAT - GREEN	1 PACK
C.	1040623	ECONOMY, FOLDING SEAT - GRAY	1 PACK
D.	1040624	ECONOMY, FOLDING SEAT - CHARCOAL	1 PACK
E.	1040625	ECONOMY, FOLDING SEAT - RED	1 PACK
F.	1040628	ECONOMY, FOLDING SEAT - TAN	1 PACK
G.	1040629	ECONOMY, FOLDING SEAT - WHITE	1 PACK
H.	1040623-PDQ	FOUR PACK PDQ, FOLDING SEAT - GRAY	4 PACK
I.	1040629-PDQ	FOUR PACK PDQ, FOLDING SEAT - WHITE	4 PACK



## ECONOMY CAMO

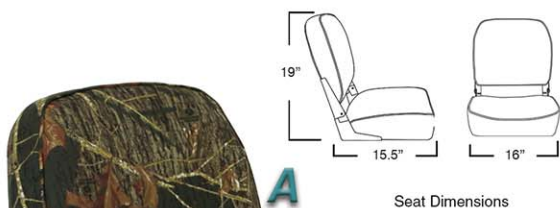

IMAGE	PART NUMBER	DESCRIPTION	PACK QUANTITY
A.	1040626	ECONOMY CAMO, FOLDING SEAT - MOSSY OAK™ BREAK-UP	1 PACK
B.	1040627	ECONOMY CAMO, FOLDING SEAT - MOSSY OAK™ DUCK BLIND	1 PACK

Comfortable cushioned seat to support your backside. Strap with snap to keep seat secure when folded down. Rigid injection molded frame.

- Folds down easily
- Black e-coated hinges
- Universal mounting pattern: 5" x 5"



Pinchless Hinge



Folded View

## XXL FOLDING SEAT

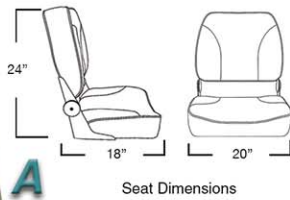

IMAGE	PART NUMBER	DESCRIPTION	PACK QUANTITY
A.	1040691	XXL, FOLDING SEAT - GRAY & BLUE	1 PACK
B.	1040693	XXL, FOLDING SEAT - CHARCOAL & GRAY	1 PACK
C.	1040697	XXL, FOLDING SEAT - MOSSY OAK™ DUCK BLIND	1 PACK

Designed for the plus size body frames. Marine grade vinyl with plush foam padding. Heavy-duty powder coated hinges. Strap with snap to keep seat secure when folded down.

- Folds down easily
- Extra wide seat
- Heavy-duty pinchless hinges
- 5 x 5 Mount
- Strap on back for secure seat fastening



## DOUBLE WIDE SEAT FOLDING



IMAGE	PART NUMBER	DESCRIPTION	PACK QUANTITY
A.	1042039	DOUBLE WIDE FOLDING SEAT - WHITE	1 PACK

Double Wide Seat. Marine grade vinyl with plush foam padding. Heavy-duty powder coated hinges.

- Folds down easily
- Heavy-duty pinchless hinges
- Quilted Stitch Pattern

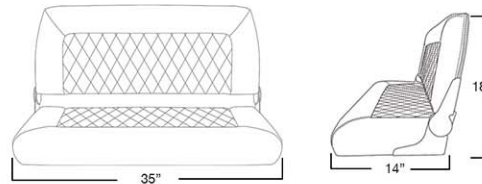

## FOLDING SEAT PACKAGE



A



B



IMAGE	PART NUMBER	DESCRIPTION	PACK QUANTITY
A.	1061100	TRAVELER CHAIR PACKAGE W/ CUSHIONS	1 PACK
B.	1001003	SKIPPER CHAIR PACKAGE W/ CUSHIONS	1 PACK

Traveler Chair Package Includes:

- Traveler fold down seat with cushions
- 15" fixed height pedestal with 9" floor base, anodized finish
- KingPin™ seat mount with e-coat finish and rotates 360°

Dimensions are from deck to top of pedestal, and may vary slightly.

Skipper Chair Package Includes:

- Skipper injection molded seat with cushions
- 15" fixed height pedestal with 9" floor base, anodized finish
- Locking Trac-Lock™ swivel, rotates 360°

Dimensions are from deck to top of pedestal, and may vary slightly.



## DECK CHAIR PREMIUM



IMAGE	PART NUMBER	DESCRIPTION	PACK QUANTITY
A.	1080021-SS	DECK FOLDING CHAIR - STAINLESS STEEL TUBING	1 PACK
B.	1080125-CR	PREMIUM DECK CHAIR	1 PACK

Dual 1" stainless steel tubing, eight legged frame with rubber capped feet for extra stability. Folds down easily for transportation.

- Durable plastic substrate
- Stainless steel tubing
- Weather resistant marine grade vinyl



Cup Holder

- Durable plastic substrate
- Aluminum Tubing
- Weather resistant marine grade vinyl
- Premium Padded Foam Armrest
- Cup Holder In Armrest
- Extra Thick Padding

## DECK CHAIR CLASSIC



IMAGE	PART NUMBER	DESCRIPTION	PACK QUANTITY
A.	1080021	DECK FOLDING CHAIR - STANDARD	1 PACK
B.	1080021-EMB	DECK FOLDING CHAIR - EMBROIDERED SAIL FISH	1 PACK
C.	1080022	DECK FOLDING CHAIR - WITH GIMBAL	1 PACK
D.	1080021-DB	DECK FOLDING CHAIR - MOSSY OAK™ DUCK BLIND	1 PACK
E.	2100300	BOLT ON GIMBAL	1 PACK

Take these chairs wherever you go. Perfect for picnics, decks, docks or the action station for the fighting fisherman. Folds down easily for transportation.

- Durable plastic substrate
- Heavy-duty aluminum tubing
- Weather resistant marine grade vinyl
- Embroidered sail fish (EMB only)



Bolt on Gimbal 2100300  
Fits Any Deck Chair (Available Separate)



Detail of Embroidering



## DECK CHAIR



IMAGE	PART NUMBER	DESCRIPTION	PACK QUANTITY
A.	1080121	DECK FOLDING CHAIR - EUROPEAN STYLE	1 PACK
B.	1080120	HIGH BACK DECK FOLDING CHAIR - BLUE	1 PACK

Folds flat, locking bar keeps legs locked in place for extra stability. Can be used with or without cushions. Includes back and seat cushions.

- Cushions are removable
- Weather resistant marine grade vinyl
- Plastic armrests
- Aluminum Frame



B

- Blue Canvas Cover
- Padded Head Rest and Leg Rest
- Wood Arm Rest
- Aluminum Frame

## PRO-STAND UP

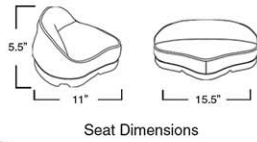

IMAGE	PART NUMBER	DESCRIPTION	PACK QUANTITY
A.	1040211	PRO STAND-UP SEAT - BLUE	1 PACK
B.	1040212	PRO STAND-UP SEAT - BLACK	1 PACK
C.	1040213	PRO STAND-UP SEAT - GRAY	1 PACK
D.	1040214	PRO STAND-UP SEAT - TAN	1 PACK
E.	1040215	PRO STAND-UP SEAT - RED	1 PACK
F.	1040216	PRO STAND-UP SEAT - WHITE	1 PACK
G.	1040217	PRO STAND-UP SEAT - MOSSY OAK™ DUCK BLIND	1 PACK



## STAND UP



IMAGE	PART NUMBER	DESCRIPTION	PACK QUANTITY
A.	1040213-NS	STAND-UP SEAT, ECONOMY - GRAY	1 PACK
B.	1040216-NS	STAND-UP SEAT, ECONOMY - WHITE	1 PACK
C.	1040212-NS	STAND-UP SEAT, ECONOMY - BLACK	1 PACK



## FOLDING CASTING SEAT



IMAGE	PART NUMBER	DESCRIPTION	PACK QUANTITY
A.	1040230-01	FOLDING CASTING SEAT - CHAR & GRAY	1 PACK

Folding Casting Seat Offers Support for your back and legs while fishing.

- Mount to any Stand up seat pedestal
- 5 x 5 Seat pattern
- Pinchless Hinge



## CONTROL POST



IMAGE	PART NUMBER	DESCRIPTION	PACK QUANTITY
A.	1040350-SL	SPRING-LOCK™ CONTROL POST, CHARCOAL GRAY SEAT	1 PACK
A.	1040351-SL	SPRING-LOCK™ CONTROL POST, MICA TAN SEAT	1 PACK
B.	1040352-PIC	PLUG-IN™ CONTROL POST, CHARCOAL GRAY SEAT	1 PACK
B.	1040352-PIM	PLUG-IN™ CONTROL POST, MICA TAN SEAT	1 PACK
C.	1040353-TLC	TAPER-LOCK™ CONTROL POST, CHARCOAL GRAY SEAT	1 PACK
C.	1040353-TLM	TAPER-LOCK™ UNIVERSAL PED-MICA	1 PACK
D.	1040355-KPC	KINGPIN™ CONTROL POST, CHARCOAL GRAY SEAT - THREADED	1 PACK
D.	1040355-KPM	KINGPIN™ CONTROL POST, MICA TAN SEAT - THREADED	1 PACK
E.	1040357-KPC	KINGPIN™ CONTROL POST, CHARCOAL GRAY SEAT - STANDARD	1 PACK
E.	1040357-KPM	KINGPIN™ CONTROL POST, MICA TAN SEAT - STANDARD	1 PACK



# Seating

## FIRST MATE MOLDED

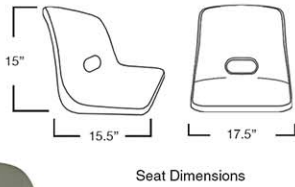

IMAGE	PART NUMBER	DESCRIPTION	PACK QUANTITY
A.	1061014-S	FIRST MATE, MOLDED SEAT - GRAY	6 PACK
B.	1061014-SG	FIRST MATE, MOLDED SEAT - GREEN	6 PACK

First Mate molded seats are one piece molded shells, made from PP plastic. Durable and lightweight, for years of carefree use.

- Durable plastic
- Universal mounting pattern: 5" x 5"
- Stack for retail presentation



## ROTATIONAL MOLDED

One piece white molded shell, made from LLDPE plastic with UV inhibitors for years of carefree use. Available in a variety of shapes and styles.

For proper support use mounting plate #3100207 or any Trac-Lock™ slide (sold separately).

Seat cushions are available in off white for each seat style. Cushions are made from plush foam padding covered with marine grade vinyl. Designed with heat seal channels and quick dry construction. Cushions snaps easily to the seat.



Cushions



Mounting Plate



MOLD #	#1	#2	#3	#4	#13	#16
1 PACK	NEW PORT	COMMODORE	YACHTSMAN II	SEAFARER	BLUEWATER	ADMIRAL
SEAT SHELL ONLY:	1060002-S	1060206-S	1060410-S	1060610-S	1061205-S	1061405-S
SEAT SHELL W/ CUSHION & MOUNTING PLATE:	1060004-C	1060204-C	1060407-C	1060605-C	1061201-C	-
SEAT SHELL W/ MOUNTING PLATE:	1060004	1060204	1060407	1060605	1061201	1061403
10 PACK OEM:	1060002-M	1060206-M	1060410-M	1060610-M	1061205-M	1061405-M
WHITE CUSHIONS:	1045014	1045020	1045028	1045014	1045035	1045036
DIMENSIONS:	18"Hx20"Wx16"D	19"Hx20"Wx16"D	17"Hx21.5"Wx16"D	17"Hx16"Wx14"D	19.5"Hx25"Wx17"D	17"Hx19"Wx16"D



## NEWPORT PACKAGE



IMAGE	PART NUMBER	DESCRIPTION	PACK QUANTITY
A.	1060100	NEWPORT ADJUSTABLE PACKAGE	1 PACK
B.	1060100-L	NEWPORT CHAIR PACKAGE, 15"PED W/ SLIDE LOCKING	1 PACK

**Package Includes:**

- Newport molded seat with off white cushions
- 2-3/8" locking Trac-Lock™ swivel, rotates 360°
- Manual adjustable pedestal with 9" floor base, satin finish

Dimensions are from deck to top of swivel, and may vary slightly.



## COMMODORE PACKAGE



IMAGE	PART NUMBER	DESCRIPTION	PACK QUANTITY
A.	1000202	COMMODORE ADJUSTABLE PACKAGE	1 PACK
B.	1000205-L	COMMODORE FIXED HEIGHT PACKAGE	1 PACK

**A. Package Includes:**

- Commodore molded seat with off white cushions
- 2-3/8" locking Trac-Lock™ swivel, rotates 360°
- Manual adjustable pedestal with 9" floor base, satin finish
- Extends from 13" - 16"

**B. Package Includes:**

- Commodore molded seat with off white cushions
- 2-7/8" locking Trac-Lock™ slide & swivel, rotates 360°
- Slide travels 5-1/4" fore and aft
- 15" fixed height pedestal with 9" round floor base, anodized finish

Dimensions are from deck to top of swivel, and may vary slightly.



## YACHTSMAN PACKAGE



IMAGE	PART NUMBER	DESCRIPTION	PACK QUANTITY
A.	1001414-L	YACHTSMAN FIXED HEIGHT PACKAGE	1 PACK

**Package Includes:**

- Yachtsman molded seat with off white cushions
- 2-7/8" locking Trac-Lock™ slide & swivel, rotates 360°
- Slide travels 5-1/4" fore and aft
- 15" fixed height pedestal with 9" round floor base, anodized finish

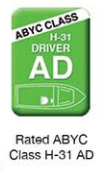

## BLUEWATER PACKAGE

MOLDED SEATS



IMAGE	PART NUMBER	DESCRIPTION	PACK QUANTITY
A.	1001204-L	BLUEWATER ADJUSTABLE PACKAGE	1 PACK

A. Package Includes:

- Bluewater molded seat with off white cushions
- 2-3/8" locking Track-Lock™ air-ride slide & swivel, rotates 360°
- Slide travels 5-1/4" fore and aft
- Air-powered adjustable mainstay with 9" round base, anodized finish



Rated ABYC Class H-31 AD

One of our largest molded seats! Cushions are made with plush foam padding covered in marine grade vinyl and snap easily onto seat. Designed for the plus size body frame

Dimensions are from deck to top of swivel, and may vary slightly.

## SEAFARER PACKAGE



IMAGE	PART NUMBER	DESCRIPTION	PACK QUANTITY
A.	1000605-L	SEAFARER FIXED HEIGHT PACKAGE	1 PACK

A. Package Includes:

- Seafarer molded seat with off white cushions
- 2-7/8" locking Trac-Lock™ swivel, rotates 360°
- 15" fixed height pedestal with 9" round base, anodized finish



Rated ABYC Class H-31 AD

One of our smallest molded seats! Cushions are made with plush foam padding covered in marine grade vinyl and snap easily onto seat.

Dimensions are from deck to top of swivel, and may vary slightly.

## ADMIRAL PACKAGE



IMAGE	PART NUMBER	DESCRIPTION	PACK QUANTITY
A.	1001408-L	ADMIRAL FIXED HEIGHT PACKAGE	1 PACK

A. Package Includes:

- Admiral molded seat (cushions sold separately)
- 2-7/8" locking Trac-Lock™ swivel, rotates 360°
- 15" fixed height pedestal with 9" round base, anodized finish



Rated ABYC Class H-31 AD

Dimensions are from deck to top of swivel, and may vary slightly.

## FLIP BACK SEAT



IMAGE	PART NUMBER	DESCRIPTION	PACK QUANTITY
A.	1042046	FLIP BACK SEAT - WHITE W/ SLIDE BENCH MOUNT	1 PACK
B.	1042047	FLIP BACK SEAT - WHITE W/O SLIDE	1 PACK

Conveniently flips in either direction for your boating needs. Can use two seats for side by side seating. Constructed with heavy-duty marine grade vinyl over plush foam padding.

- Back moves fore and aft
- Off white upholstery
- Weather resistant marine grade vinyl
- Universal mounting pattern: 5" x 12"



Back View

## BENCH DOUBLE BUCKET

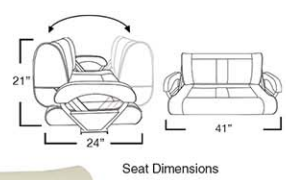

IMAGE	PART NUMBER	DESCRIPTION	PACK QUANTITY
A.	1042050	DOUBLE BUCKET SEAT	1 PACK
A.	2100196	REPLACEMENT COVER	1 PACK

Bench seating for two. Unique flip back feature allows for fore and aft seating. Thick foam padding covered in marine grade vinyl over a high-strength composite substrate. Works with pedestal or box style mounting.

- Provides 35.5" of seating area
- Back moves fore and aft
- Off white upholstery



Back View

## TWIN 46 FLIP-UP SEAT



IMAGE	PART NUMBER	DESCRIPTION	PACK QUANTITY
A.	1043001	TWIN 46 FLIP-UP SEAT	1 PACK

Lots of versatility with this seat. A comfortable seat or flip-up bolster for leaning and standing position, or flip the chair back for the fore and aft position. Foam padding covered with weather resistant marine grade vinyl.

- Flip-up bolster
- Back moves fore and aft
- Off white upholstery
- Universal mounting pattern: 5" x 5"

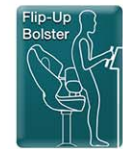

Lean Position

# Seating

## DELUXE SPORT FLIP-UP

MOLDED SEATS

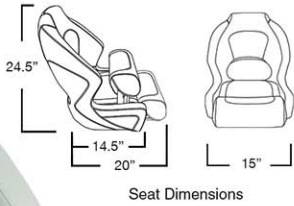
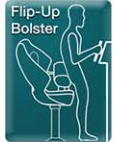

IMAGE	PART NUMBER	DESCRIPTION	PACK QUANTITY
A.	1043251	DELUXE SPORT FLIP-UP SEAT - NAVY & WHITE	1 PACK
B.	1043253	DELUXE SPORT FLIP-UP SEAT - CHARCOAL & WHITE	1 PACK
C.	1043259	DELUXE SPORT FLIP-UP SEAT - WHITE	1 PACK
D.	1043263	DELUXE SPORT FLIP-UP SEAT - CHARCOAL & GRAY	1 PACK

Comfort and support seat, flip-up bolster for standing or leaning positions. Blow molded frame, with molded foam. Premium high quality upholstery with marine grade vinyl.

- Sorrento Vinyl
- Flip-up bolster
- Light weight blow molded frame
- Weather resistant marine grade vinyl
- Universal mounting pattern: 5" x 12"



## DELUXE SPORT BUCKET

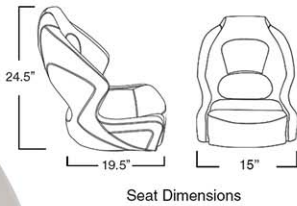

IMAGE	PART NUMBER	DESCRIPTION	PACK QUANTITY
A.	1043691	DELUXE SPORT SEAT - NAVY & WHITE	1 PACK
B.	1043693	DELUXE SPORT SEAT - CHARCOAL & WHITE	1 PACK
C.	1043699	DELUXE SPORT SEAT - WHITE	1 PACK

Premium upholstery and cushions are designed to provide maximum comfort and quality. Durable blow molded frame with ergonomically molded cushions and extended sides for extra support.

- Sorrento Vinyl
- Weather resistant marine grade vinyl
- Universal mounting pattern: 5" x 12"



## SUBSTRATE & FOAM DELUXE SPORT



IMAGE	PART NUMBER	DESCRIPTION	PACK QUANTITY
A.	1043250-SFB	DELUXE SPORT FLIP-UP SEAT - SUB, FOAM, & BOLSTER ONLY	1 PACK
B.	1043250-SFB1	DELUXE SPORT FLIP-UP SEAT - SUB, FOAM, PARALLEL BOLSTER	1 PACK
C.	1043250-SF	DELUXE SPORT SEAT - SUB, FOAM	1 PACK

Premium upholstery and cushions are designed to provide maximum comfort and quality. Durable blow molded frame with ergonomically molded cushions and extended sides for extra support.

- Universal mounting pattern: 5" x 12"



BOTTOM OF SUBSTRATE

## OZARK SPORT II

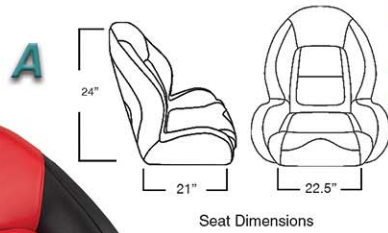

IMAGE	PART NUMBER	DESCRIPTION	PACK QUANTITY
A.	1043325	OZARK SPORT II, RED & BLACK	1 PACK
B.	1043334	OZARK SPORT II, WHITE & BLACK	1 PACK



The Ozark Sport II seat with premium high quality upholstery and cushions on a rigid aluminum frame built maximum support and comfort.

- Premium Upholstery
- Weather resistant marine grade vinyl
- Universal mounting pattern: 5" x 5" & 5" x 12"
- Molded Foam Cushions

UPHOLSTERED SEATS

## OZARK SEATS

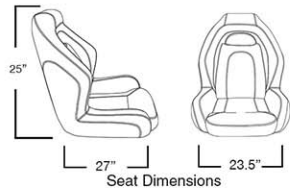

IMAGE	PART NUMBER	DESCRIPTION	PACK QUANTITY
A.	1003224	OZARK, 3-PIECE BENCH - CHARCOAL & METEOR GRAY	1 PACK
B.	1043224	OZARK, SEAT - CHARCOAL & METEOR GRAY	1 PACK
C.	1043224-B	OZARK, SEAT W/ BOLSTER - CHARCOAL & GRAY	1 PACK
D.	1043224-CS	OZARK, CENTER FOLDING SEAT - CHARCOAL & GRAY	1 PACK
E.	1040224	OZARK, CASTING SEAT - CHARCOAL & GRAY	1 PACK

The Ozark seat is available in a variety of options and styles, with premium high quality upholstery and cushions on a rigid aluminum frame for maximum support and comfort.

- Premium Upholstery
- Weather resistant marine grade vinyl
- Universal mounting pattern: 5" x 5" & 5" x 12"



## SUBSTRATE & FOAM OZARK

IMAGE	PART NUMBER	DESCRIPTION	PACK QUANTITY
A.	1043200-SFB	OZARK, SEAT - SUB, FOAM & BOLSTER	1 PACK
B.	1043200-SF	OZARK, SEAT - SUBSTRATE & FOAM	1 PACK
C.	1043200-SFB1	OZARK, SEAT - SUB, FOAM & BOLSTER PARALLEL	1 PACK



## SPORT BUCKET SEAT

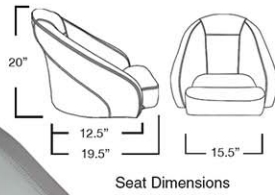

Seat Dimensions

IMAGE	PART NUMBER	DESCRIPTION	PACK QUANTITY
A.	1043501	SPORT BUCKET FLIP-UP SEAT - WHITE	1 PACK
B.	1040407	DELUXE BUCKET SEAT - WHITE	1 PACK

Comfort and smooth riding on this seat. Plush foam padding covered in marine grade vinyl. Flip-up bolster converts easily from sit down to stand up leaning support. Rugged aluminum tubing bent and welded with molded foam.

- Flip-up bolster
- Heavy-duty aluminum frame
- Weather resistant marine grade vinyl
- Universal mounting pattern: 5" x 12"

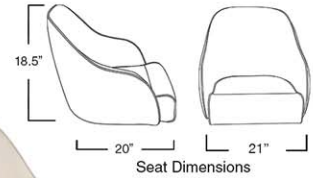

Seat Dimensions



A



A

Lean Position



B

## ROYAL SEAT

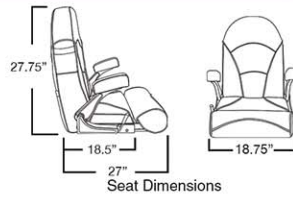

Seat Dimensions

IMAGE	PART NUMBER	DESCRIPTION	PACK QUANTITY
A.	1040800	ROYAL FLIP-UP SEAT - WHITE	1 PACK
B.	1040800-NB	ROYAL SEAT - WHITE	1 PACK

Comfortable full size helm or captain's seat when flipped down. Flip-up the bolster for standing or leaning position. Armrest also flip-up and out of the way. Heavy-duty marine grade vinyl over plush foam padding.

- Flip-up bolster
- Large dry pocket on back of seat
- Weather resistant marine grade vinyl
- Use with short Cam-Lock, PN: 3100931 (sold separately)
- Mounting pattern: 5.25" x 9"
- Flip-Up Arm Rests
- Reclines 45 Degrees



A



B



A

Lean Position

## SPORT HELM SEAT

IMAGE	PART NUMBER	DESCRIPTION	PACK QUANTITY
A.	1040820-01	SPORT HELM SEAT WI BOLSTER - BLACK	1 PACK
A.	1040820-02	SPORT HELM SEAT WI BOLSTER - WHITE	1 PACK
B.	1040825-01	SPORT HELM DOUBLE WI BOLSTER - WHITE / TAN	1 PACK
B.	1040825-02	SPORT HELM DOUBLE WI BOLSTER - WHITE	1 PACK

- Flip-up Bolster
- Flip-up Armrest
- High quality vinyl & upholstery
- Mounting pattern: 5x5 & 5x12



A



B



A

Lean Position

## STINGRAY SEAT

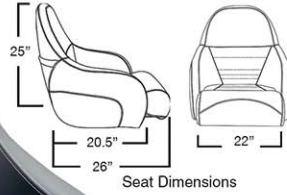

IMAGE	PART NUMBER	DESCRIPTION	PACK QUANTITY
A.	1040930-01	STINGRAY SPORT BUCKET FLIP-UP -BLACK & GRAY	1 PACK

Comfortable runabout seat or flip-up the bolster for standing and leaning position. Blow molded high-strength composite shell with high density foam padding, covered in marine grade vinyl.

- Flip-up bolster
- Weather resistant marine grade vinyl
- Universal mounting pattern: 5" x 12"



Lean Position

## OCEAN FLIP-UP SEAT

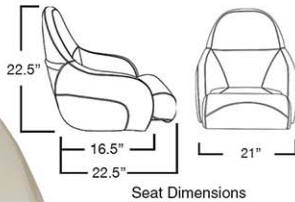

IMAGE	PART NUMBER	DESCRIPTION	PACK QUANTITY
A.	1040900	OCEAN FLIP-UP SEAT - WHITE	1 PACK

Comfortable runabout seat or flip-up the bolster for standing or leaning position. Blow molded high-strength composite shell with high density foam padding covered in marine grade vinyl.

- Flip-up bolster
- Large dry pocket on back of seat
- Weather resistant marine grade vinyl
- Universal mounting pattern: 5" x 12"



Flip-Up Bolster



Mesh Pocket

## SUBSTRATE & FOAM

IMAGE	PART NUMBER	DESCRIPTION	SIZE	PACK QUANTITY
A.	1040925-SFB	STINGRAY SPORT FLIP-UP SUB AND FOAM	H: 26" x W: 22" x D: 24"	1 PACK
B.	1043245-SFB	CLUBMAN SPORT FLIP-UP SUB AND FOAM	H: 21" x W: 21" x D: 19"	1 PACK
C.	1043240-SFB	RECON SPORT FLIP-UP SUB AND FOAM	H: 21" x W: 19.5" x D: 22"	1 PACK

- Blow molded substrate with molded foam & Flip-up Bolster.



## LADDER BACK SEATS



IMAGE	PART NUMBER	DESCRIPTION	PACK QUANTITY
A.	1061301	LADDER BACK SEAT - WI WHITE CUSHIONS	1 PACK
B.	1061302	LADDER BACK SEAT - WI WHITE CUSHIONS & GIMBAL	1 PACK
C.	1061311	LADDER BACK SEAT - WI/O CUSHIONS	1 PACK

2 piece plastic injection seat covered with a UV-stabilized polypropylene substrate for durability. Molded armrests with polished aluminum brackets.

- Molded grab handle on back of seat
- Removable snap on cushions
- Universal mounting pattern: 5" x 12"

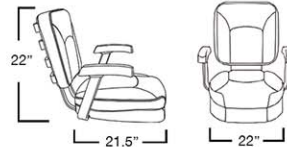

Seat Dimensions



## LADDER BACK CHAIR PACKAGES



IMAGE	PART NUMBER	DESCRIPTION	PACK QUANTITY
A.	1001303	LADDER BACK CHAIR PACKAGE	1 PACK
B.	1001304	LADDER BACK CHAIR PACKAGE WI GIMBAL	1 PACK

A. Package Includes:

- 2 piece plastic injection seat with armrests and white cushions
- 2-7/8" Trac-Lock™ slide/swivel (locking) rotates 360° & travels 5-1/4" fore and aft
- 18" fixed height pedestal with 9" round base, anodized finish

B. Package Includes:

- 2 piece plastic injection seat with armrests, gimbal, and white cushions
- 2-7/8" Trac-Lock™ slide/swivel (locking) rotates 360° & travels 5-1/4" fore and aft
- 18" fixed height pedestal with 9" round base, anodized finish



Rated ABYC  
Class H-31 AD

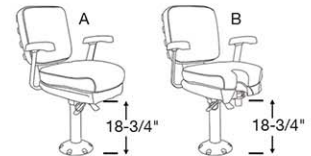

Dimensions are from top of deck to top of slide & swivel and may vary slightly

## FOLD DOWN BENCH

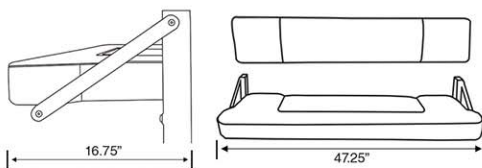
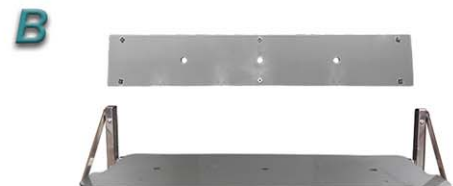

IMAGE	PART NUMBER	DESCRIPTION	PACK QUANTITY
A.	1081093	FOLD DOWN BENCH SEAT - WHITE & GRAY	1 PACK
B.	1081000-F	FOLD DOWN BENCH SEAT - FRAME ONLY	1 PACK

Simply lift back of seat and fold down for easy storage.

- Stainless Steel Frame
- Marine Grade Vinyl
- Foam Cushion





## DELUXE UPHOLSTERED

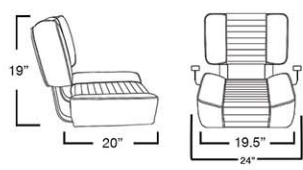

Seat Dimensions

IMAGE	PART NUMBER	DESCRIPTION	PACK QUANTITY
A.	1040809	DELUXE UPHOLSTERED SEAT - WHITE	1 PACK
B.	1040002	DELUXE CAPTAIN'S SEAT - SEAT W/ ARMRESTS - WHITE	1 PACK
C.	1040009	DELUXE CAPTAIN'S SEAT - SEAT W/ ARMRESTS - BLACK	1 PACK

Perfect for comfortably riding out rough conditions. High density foam cushions covered in marine grade vinyl for maximum comfort and durability.

- Anodized aluminum back support bars.
- (B.) Armrest supports and cushions
- Plastic durable substrate



A



B



C



Side View

## DELUXE CHAIR STAND



IMAGE	PART NUMBER	DESCRIPTION	PACK QUANTITY
A.	1020003	DELUXE CAPTAIN'S CHAIR PACKAGE - WHITE	1 PACK
B.	1020009	DELUXE CAPTAIN'S CHAIR PACKAGE - BLACK	1 PACK
C.	1080018	DELUXE CAPTAIN'S CHAIR STAND WITH SWIVEL	1 PACK

Seat rotates 360°. Chair stand has 1" anodized legs with rubber tip guards.

- Anodized aluminum arms and back support bars.
- Plastic durable substrate



A



B



C

Deluxe Chair Stand with Swivel

## BAR STOOLS

IMAGE	PART NUMBER	DESCRIPTION	PACK QUANTITY
A.	1081224-G	24" STAINLESS STEEL BAR STOOL PACKAGE	1 PACK
B.	1081224-GAL	24" ALUMINUM BAR STOOL PACKAGE	1 PACK
A.	1081230-G	30" STAINLESS STEEL BAR STOOL PACKAGE	1 PACK
B.	1081230-GAL	30" ALUMINUM BAR STOOL PACKAGE	1 PACK
C.	1081233	BAR STOOL SEAT - GRAY	1 PACK

Durable 15" round bar stool seat with thick plush cushion provides support and comfort. 2-7/8" pedestal, available in 316 mirror finish stainless steel or high strength aluminum.

- Stainless steel arched back support
- Chrome Trac-Lock™ swivel
- 14" Round stainless steel or aluminum footrest



A

Stainless Steel



B

Aluminum



C

15" Round Bar Stool Seat



## LEANING POST



IMAGE	PART NUMBER	DESCRIPTION	PACK QUANTITY
A.	1080080	LEANING POST W/ CUSHION	1 PACK
B.	1080085	BACKREST WITH CUSHIONS AND FRAME - WHITE	1 PACK
C.	1080088	ROD HOLDER FRAME	1 PACK
D.	1045075	BACKREST CUSHION ONLY - WHITE	1 PACK
E.	1045070	SEAT CUSHION ONLY - WHITE	1 PACK

High-strength aluminum bent and welded frame. Thick foam padding covered with marine grade vinyl. Leaning post packed in a box the size of cushion for shipping and storage.

- Easy assembly and installation
- Mounting hardware included
- Modular back rest and rod holder

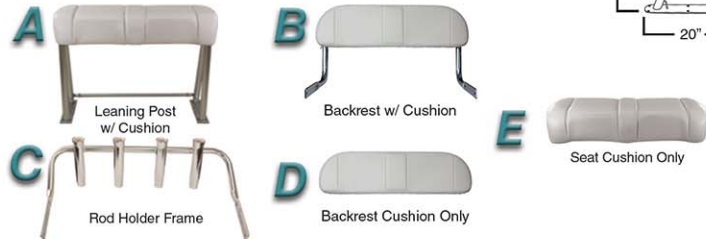
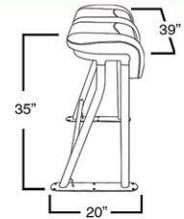

## COOLER SEAT



IMAGE	PART NUMBER	DESCRIPTION	PACK QUANTITY
A.	1042010	COOLER FLIP BACK SEAT - WHITE	1 PACK
B.	1042010-SF	COOLER FLIP BACK SEAT - NO UPHOLSTERY	1 PACK

Back rest conveniently flips in either direction. Thick foam padding covered in marine grade vinyl. Seat/Lid opens up to cooler keeping your drinks and food fresh all day.

- 72 quarts
- Aluminum rails with stainless steel hardware
- Dimensions: 37" H x 32" W x 18-1/2" D
- Seating height: 20-1/2" H



## DOCK BENCH



IMAGE	PART NUMBER	DESCRIPTION	PACK QUANTITY
A.	1099050-2	ALUMINUM DOCK BENCH	1 PACK
B.	1099050-2A	ALUMINUM DOCK BENCH - ARMRESTS	1 PACK

Strong anodized aluminum frame with extruded aluminum support legs.

- Easy to assemble
- Heavy duty design
- Weather resistant for harsh marine environment
- Packs neatly into box (19" W x 42" L x 5" D)
- H: 30" x W: 38.75" x D: 12"
- Anodized Aluminum



## MARINER HELM

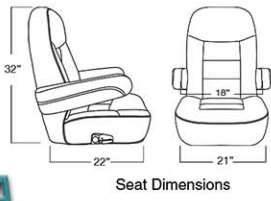

IMAGE	PART NUMBER	DESCRIPTION	PACK QUANTITY
A.	1042081-BC	MARINER HELM CHAIR - BLACK / CHARCOAL	1 PACK
B.	1042080-W	MARINER HELM CHAIR - WHITE	1 PACK
C.	1042080-B	MARINER HELM CHAIR - BLACK	1 PACK

Luxury helm seat with plush foam padding covered in marine grade vinyl and heavy-duty powder coated steel frame.

- Back reclines 45 degrees
- Armrests flip up - out of the way
- Universal mounting pattern: 5" x 12"



## WHEELHOUSE HELM

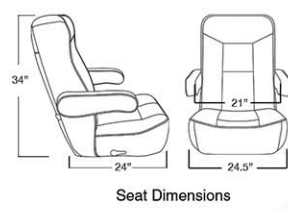

IMAGE	PART NUMBER	DESCRIPTION	PACK QUANTITY
A.	1042120-XLB1	WHEELHOUSE XL HELM SEAT - BLACK	1 PACK

Wheelhouse Helm seat offers a heavy-duty powder coated steel shock absorbing suspension seat frame with 9" thick foam cushions covered in marine grade vinyl.

- Back reclines 45 degrees
- Armrests flip up - out of the way
- Universal mounting pattern: 5" x 12"
- Adjustable Arm Rest
- Pocket on back of seat



## HELMSMAN HELM

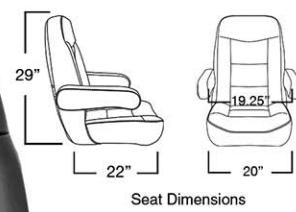

IMAGE	PART NUMBER	DESCRIPTION	PACK QUANTITY
A.	1042110-B1	HELMSMAN RECLINING PILOT SEAT - BLACK	1 PACK

Helmsman Pilot seat offers a heavy-duty powder coated steel shock absorbing suspension seat frame. 6" thick foam cushions covered in marine grade vinyl.

- Back reclines 45 degrees
- Armrests flip up - out of the way
- Designed for 5" x 12" slide - no mounting plate required



# Seating

HELM SEATS

## NORWEGIAN HELM



A

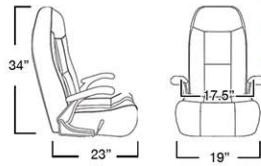

Seat Dimensions



B



C

Light Blue Stitching Embedded in Fabric

IMAGE	PART NUMBER	DESCRIPTION	PACK QUANTITY
A.	1042064	NORWEGIAN HELM SEAT - WHITE	1 PACK
B.	1042066	NORWEGIAN HELM SEAT - BLACK	1 PACK
C.	1042093	NORWEGIAN HELM SEAT - BLK / CHAR / FABRIC	1 PACK

Luxury Helm seat provides maximum comfort for long rides. Plush foam padding covered with heavy-duty marine grade vinyl. Light weight aluminum frame.

- Back reclines 45 degrees
- Armrests flip-up - out of the way
- Weather resistant marine grade vinyl
- Universal mounting pattern: 5" x 12"

## PONTOON RECLINE

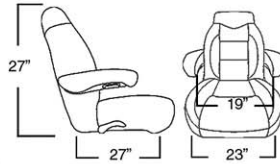

Seat Dimensions

IMAGE	PART NUMBER	DESCRIPTION	PACK QUANTITY
A.	1042185-01	PONTOON HELM RECLINE - CREAM	1 PACK

Pontoon Recline Seat offers a heavy-duty powder coated steel frame with suspension springs. 6" Foam cushions covered in marine grade vinyl.

- Back reclines 45 degrees
- Adjustable Armrests flip-up - out of the way
- Weather resistant marine grade vinyl
- Universal mounting pattern: 5" x 12"



ARMREST ANGLE ADJUSTMENT



Side Angle

## PONTOON FIXED

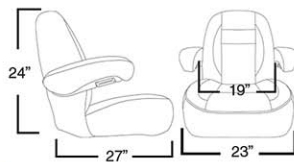

Seat Dimensions

IMAGE	PART NUMBER	DESCRIPTION	PACK QUANTITY
A.	1042180-01	PONTOON HELM FIXED - CREAM	1 PACK

Pontoon Fixed Seat offers a heavy-duty powder coated steel frame with suspension springs. 6" Foam cushions covered in marine grade vinyl.

- Adjustable Armrests flip-up - out of the way
- Weather resistant marine grade vinyl
- Universal mounting pattern: 5" x 12"



ARMREST ANGLE ADJUSTMENT



Side Angle

## NORWEGIAN PACKAGE

IMAGE	PART NUMBER	DESCRIPTION	PACK QUANTITY
A.	1002062	FIXED HEIGHT NORWEGIAN HELM PACKAGE - BLACK	1 PACK
B.	1002063	NORWEGIAN HELM PACKAGE, WK2 W/ MAINSTAY - BLACK	1 PACK
C.	1002093	NORWEGIAN HELM PACKAGE 2-7/8" - BLACK & CHAR	1 PACK

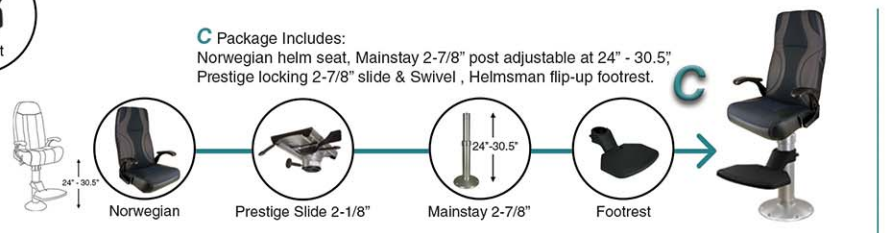
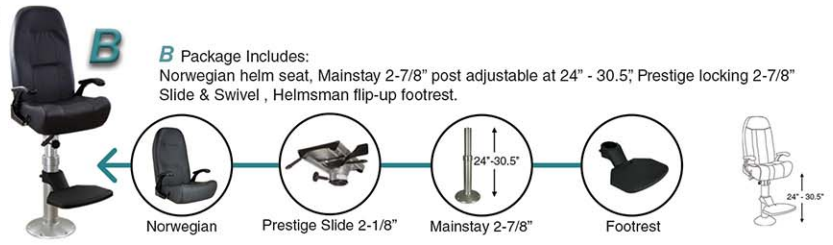

## HELMSMAN PACKAGE

IMAGE	PART NUMBER	DESCRIPTION	PACK QUANTITY
A.	1002110	ADJUSTABLE HELMSMAN HELM PACKAGE	1 PACK



Package Includes:  
Helmsman pilot helm seat, heavy-duty 4" air-ride Mariner II slide & swivel, 4" brite dip pedestal with 12" round floor base, adjusts from 18" to 28". Seat mounting footrest offers adjustable height and flips-up out of the way.



## MARINER PACKAGE

IMAGE	PART NUMBER	DESCRIPTION	PACK QUANTITY
A.	1002083	ADJUSTABLE MARINER HELM PACKAGE	1 PACK



Package Includes:  
Mariner helm seat, heavy-duty 4" air-ride Mariner II slide & swivel, 4" brite dip pedestal with 12" round floor base, adjusts from 18" to 28". Seat mounting footrest offers adjustable height and flips-up out of the way.



# Vinyl Collection

## VINYL & FABRIC FAMILY COLLECTION

(AVAILABLE IN A VARIETY OF COLORS AND STYLES)



VINYL COLLECTION



LEGACY - 197



SEDONA - 102



HERITAGE - 290

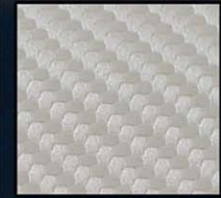

IMPERIAL - 215



GRANDEUR  
219



BELLWETHER  
041



SORRENTO  
007

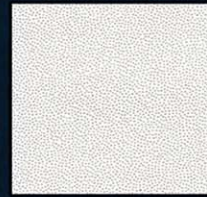

SORRENTO  
PEARL - 007



COACHMAN  
447



COACHMAN LX  
122



OPULENCE  
186

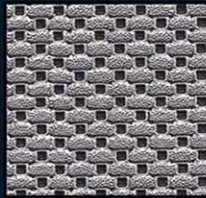

REGAL - 160



ORNATE - 189



MOSAIC - 261



CLASSIC WEAVE  
263



RATTAN - 264

### Performance Testing

### Testing Method

*meets or exceeds*

- |                        |  |
|------------------------|--|
| • Flame Retardancy:    | FMVSS 302 Flammability Test (horizontal burning)               |
| • Abrasion Resistance: | Heavy Duty Wyzenbeek ASTM D4157-92 Double Rub, 100,000+ Cycles |
| • UV Resistance:       | ASTM G35 QUV Stabilized 500 Hours, Gray Scale 3.5 min.         |
| • Cold Crack:          | -23°C Per FTMS 191A M5874                                      |
| • Mildew Treated:      | ASTM G21-2009  |
| • Anti-Bacterial:      | ATCC 147-1993  |
| • Anti-Microbial:      | ASTM 1428-99   |

Manufactured to meet the following flammability requirements:

California Technical Bulletin 117 Section E

NFPA 260

BIFMA X5.7

IMO A.652 (16) 1, 8.2 & 8.3

DIN 4102 B2

FAA, FAR. 25.853

UIFAC Class 1

NF P92-503 M2

EN 1021 Part 1 & 2



Marine Equipment Directive 96/98/EC

CATALOG AVAILABLE FOR DOWNLOAD AT:



## PASSENGER VESSEL

# Passenger Vessel Seating

The Passenger Vessel assortment has been developed in partnership with Modell Møbler Marine Seating, an international innovator in the field of marine furniture. With focus on leisure craft and passenger ferries, quality designs ensure that passengers enjoy a pleasant trip with a high degree of comfort.

From cabin seating and comfort seating, all the way to crew seating, Springfield Marine has it all! Including top of the line, easy to customize passenger accessories for all your seating applications.

## Offshore & Commercial Catalog now available



Senja High (Double Seat)



Bahama Turn Up

Officially Licensed By



Bahama Diplomat Extended

# KingPin™ Series

## ABOUT KINGPIN™

Springfield Marine's first generation removable pedestal, the KingPin™ is still the most popular seating system among freshwater boaters. The centerpiece of the KingPin™ system is the Hi-Lo pedestal. In the Hi position, the pedestal is a comfortable fishing seat. Remove the post and insert the seat mount into the base for the Lo position - ideal for compact storage to provide maximum visibility for the driver while the boat is underway.

It's simple... a 3/4" E-Coated steel pin extends from the bottom of the pedestal as well as from the bottom of the seat mount. And each pin fits into the socket of the KingPin™ deck base. Aluminum post available in anodized, e-coated or polished.

Springfield Marine offers the KingPin™ system in a choice of two styles... Standard and Threaded. The Standard pin, with its high-strength composite clip, is designed to prevent unintentional detachment. Threaded has a threaded pin at the bottom of the post which can simply and easily be threaded into the base. Both systems provide an effective, safe, and secure boating experience, that meet the ABYC H-31 standard for fishing positions.

Posts have been updated to Anodized for corrosion resistance and visual appeal.

System meets ABYC H-31 B Rating.

Use On **Pontoon Boats** **Small Boats** **Fishing Boats**

**Standard** **Threaded**

PRODUCTS IN THE KINGPIN™ SERIES ARE DESIGNED FOR RECREATIONAL USE ONLY

ABYC CLASS H-31 FISHING ONLY B



KINGPIN™ SERIES

PACKAGES • SEAT MOUNTS • PEDESTALS • BASES • ACCESSORIES



## HI-LO 3-PIECE PACKAGE

RETAIL IMAGE	PART NUMBER	DESCRIPTION	UNIT HEIGHT	PACK QUANTITY	ABYC
A.	1615431-1	Standard Hi-Lo 3-Piece Package	13-1/2"	1 Retail	B
A.	1615433-1	Standard Hi-Lo 3-Piece Package	15-1/2"	1 Retail	B
B.	1630401-1	Threaded Hi-Lo 3-Piece Package	13-1/2"	1 Retail	B

Retail packed in box with 4 color label

Hi-Lo 3-Piece set (A.) includes the following parts:

- Standard KingPin™ 11" or 13" post (#1610411-A or 1610413-A)
- KingPin™ Hi-Lo swivel, e-coat finish (#1615201-EC)
- Standard KingPin™ 7" x 7" base, stainless steel with satin finish (#1620001)

Hi-Lo 3-Piece set (B.) includes the following parts:

- Threaded KingPin™ 11" post (#1630411-A)
- KingPin™ Hi-Lo swivel, e-coat finish (#1615201-EC)
- Threaded KingPin™ 7" x 7" base, stainless steel with satin finish (#1630001)

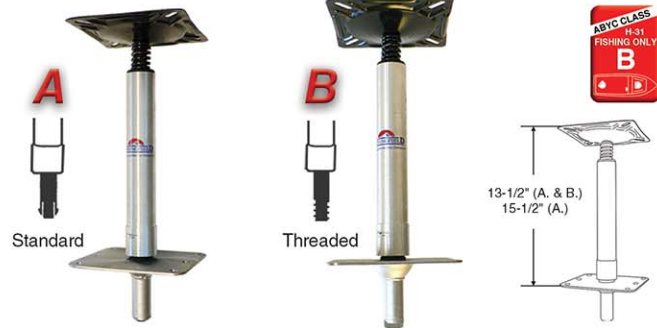

KingPin™ Sets Are Rated ABYC Class H-31 B

KINGPIN™ SERIES

## POWER-RISE STAND-UP POSTS

RETAIL IMAGE	PART NUMBER	PIN	ADJUSTS	FINISH	PACK QUANTITY	ABYC
A.	1612402-A	Standard	23-4/2" to 30-1/2"	Anodized	1 Retail	B
B.	1632013-A	Threaded	23-4/2" to 30-1/2"	Anodized	1 Retail	B

OEM IMAGE	PART NUMBER	PIN	ADJUSTS	FINISH	PACK QUANTITY	ABYC
A.	3612402-A	Standard	22-1/2" to 29-1/2"	Anodized	1 Bulk	B
B.	3632013-A	Threaded	22-1/2" to 29-1/2"	Anodized	2 Bulk	B
C.	3632013-EC	Threaded	22-1/2" to 29-1/2"	E-Coat	20 Bulk	B

Retail packages are packed in clamshell with 4 color label

Power-Rise Stand-Up posts adjust from 22-1/2" to 29-1/2" & 23-4/2" to 30-1/2"

Use with standard or threaded KingPin™ base (sold separately).

- Cast Aluminum Seat Mount with powder coat finish
- 5 x 5 bolt pattern
- 3 - Degree tilt

KingPin™ Posts are Rated ABYC Class H-31 B

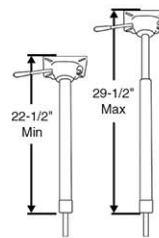

## POWER-RISE SIT DOWN POSTS

RETAIL IMAGE	PART NUMBER	PIN	ADJUSTS	FINISH	PACK QUANTITY	ABYC
A.	1612401-A	Standard	16" to 22-3/8"	Anodized	1 Retail	B
B.	1632012-A	Threaded	16" to 22-3/8"	Anodized	1 Retail	B

OEM IMAGE	PART NUMBER	PIN	ADJUSTS	FINISH	PACK QUANTITY	ABYC
A.	3612401-A	Standard	16" to 22-3/8"	Anodized	1 Bulk	B
B.	3632012-A	Threaded	16" to 22-3/8"	Anodized	1 Bulk	B
C.	3632012-EC	Threaded	16" to 22-3/8"	E-Coat	1 Bulk	B

Retail packages are packed in clamshell with 4 color label

Use with standard or threaded KingPin™ base (sold separately).

- Cast Aluminum Seat Mount with powder coat finish
- 5 x 5 bolt pattern
- 3 - Degree tilt

KingPin™ Posts are Rated ABYC Class H-31 B

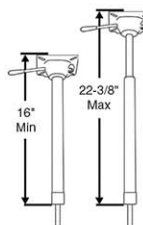

# KingPin™ Series

## POWER-RISE STAND-UP POSTS

RETAIL						
IMAGE	PART NUMBER	DESCRIPTION	PIN	PACK QUANTITY	ABYC	
A.	1611433	Power-Rise Stand Up Package	Standard	1 Retail	B	
B.	1633037	Power-Rise Stand Up Package	Threaded	1 Retail	B	

KingPin™ Posts are Rated ABYC Class H-31 B



Retail packed in box with 4 color label

Stand-Up package (A.) includes the following parts:

- Standard Power-Rise Stand-Up post (#1611431-A)
- Quik-Tilt seat mount (#1615254-EC)
- Gray Pro Stand-Up seat (#1040213)

Stand-Up package (B.) includes the following parts:

- Threaded Power-Rise Stand-Up post (#1633013-A)
- Quik-Tilt seat mount (#1615254-EC)
- Gray Pro Stand-Up seat (#1040213)



## POWER-RISE POSTS

RETAIL							
IMAGE	PART NUMBER	DESCRIPTION	FINISH	SIZE	PIN	PACK QUANTITY	ABYC
A.	1611431-A	Power-Rise Post Only	Anodized	15-1/2" - 18-1/2"	Standard	1 Bulk	B
B.	1633013-A	Power-Rise Post Only	Anodized	22-1/2" - 29-1/2"	Threaded	1 Bulk	B

KingPin™ Posts are Rated ABYC Class H-31 B



OEM							
IMAGE	PART NUMBER	DESCRIPTION	FINISH	SIZE	PIN	PACK QUANTITY	ABYC
A.	3633011-SSA	Power-Rise Post Only	Anodized	15-1/2" - 18-1/2"	Threaded Stainless Steel	10 Bulk	B
B.	3633013-A	Power-Rise Post Only	Anodized	22-1/2" - 29-1/2"	Threaded E-Coat	10 Bulk	B
B.	3633013-SSA	Power-Rise Post Only	Anodized	22-1/2" - 29-1/2"	Threaded Stainless Steel	10 Bulk	B

Power-Rise Stand-Up posts. Use with standard or threaded KingPin™ bases (sold separately). Easy stow for Rod Lockers.

Pedestals listed as SSA have a Stainless Steel Pin and Anodized post. Use with any KingPin™ seat mount.

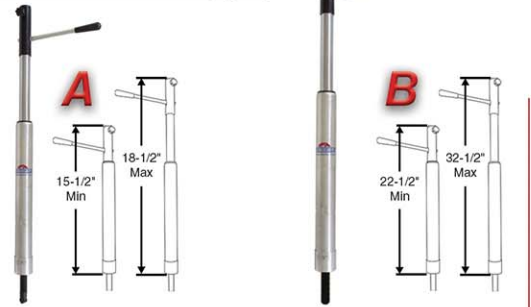
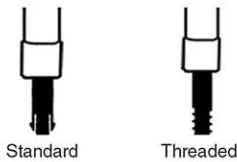

## QUIK-TILT SEAT MOUNT

RETAIL					
IMAGE	PART NUMBER	DESCRIPTION	FINISH	PACK QUANTITY	ABYC
A.	1615254-EC	Quik-Tilt Seat Mount	E-Coat	1 Bulk	B

KingPin™ Seat Mounts are Rated ABYC Class H-31 B



OEM					
IMAGE	PART NUMBER	DESCRIPTION	FINISH	PACK QUANTITY	ABYC
A.	3615254-EC	Quik-Tilt Seat Mount	E-Coat	20 Bulk	B

Retail packages are packed in clamshell with 4 color label

Unintentional detachment to comply with ABYC. E-coat rust resistant finish swivel, rotates 360° 4 snap-in angles (0°, 30°, 60°, 90°). Use with any KingPin™ post (sold separately).



## 7" X 7" SWIVEL SEAT MOUNT

RETAIL						
IMAGE	PART NUMBER	DESCRIPTION	FINISH	PACK QUANTITY	ABYC	
A.	1614201-PP	Seat Mount With Spring	Polished	6 Retail	B	
A.	1615201-EC	Seat Mount With Spring	E-Coat	6 Retail	B	
B.	1615204-EC	Seat Mount No Spring	E-Coat	6 Retail	B	

OEM						
IMAGE	PART NUMBER	DESCRIPTION	FINISH	PACK QUANTITY	ABYC	
A.	3614201-PP	Seat Mount With Spring	Polished	20 Bulk	B	
B.	3614204-PP	Seat Mount No Spring	Polished	20 Bulk	B	
A.	3615201-EC	Seat Mount With Spring	E-Coat	20 Bulk	B	
B.	3615204-EC	Seat Mount No Spring	E-Coat	20 Bulk	B	

KingPin™ Seat Mounts are Rated ABYC Class H-31 B



Retail packages are packed in clamshell with 4 color label

Unintentional detachment to comply with ABYC. E-coat or polished passivated rust resistant finish. Polished passivated swivels are stainless steel. Fits bolt pattern 4.5" to 5.5" square. Swivel rotates 360°. Seat mount has 3° tilt. Use with any KingPin™ post (sold separately).

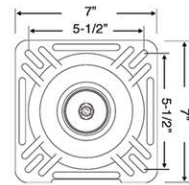

## 7" X 7" HI-RISE SEAT MOUNT

OEM						
IMAGE	PART NUMBER	DESCRIPTION	FINISH	PIN	PACK QUANTITY	ABYC
A.	3615207-ECB	7"x 7" Hi - Rise Seat Mount	E-Coat	Mild Steel	20 Bulk	B
B.	3615207-SSECB	7"x 7" Hi - Rise Seat Mount	E-Coat	Stainless Steel	20 Bulk	B

KingPin™ Seat Mounts are Rated ABYC Class H-31 B



Unintentional detachment to comply with ABYC. Aluminum cast powder coat finish, swivel rotates 360°. Use with any KingPin™ post (sold separately). Seat mount has 3° tilt.

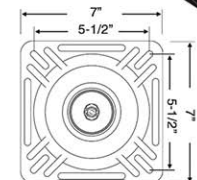

Swivel adds 2-11/16 to height of post.

## MANUAL ADJUSTABLE POSTS

RETAIL						
IMAGE	PART NUMBER	PIN	FINISH	PACK QUANTITY	ABYC	
A.	1613401-EC	Standard	E-Coat	6 Retail	B	
B.	1613402-A	Standard	Anodized	6 Retail	B	
A.	1630801-EC	Threaded	E-Coat	6 Retail	B	
B.	1630801-A	Threaded	Anodized	6 Retail	B	

KingPin™ Posts are Rated ABYC Class H-31 B



Retail packages are packed in clamshell with 4 color label

Manually adjustable posts adjusts from 22" to 31" in 1" increments. Posi-Lock lever secures post at desired height. Available in anodized or e-coat finish. Use with any KingPin™ seat mount (sold separately).

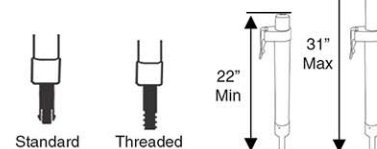

KINGPIN™ SERIES

# KingPin™ Series

## STANDARD FIXED HEIGHT POSTS

IMAGE	A.	B.	C.	RETAIL		
	HEIGHT	ANODIZED	E-COAT	BRITE DIP	PACK QUANTITY	ABYC
11"	1610411-A	1610411-EC	-	-	6 Retail	B
13"	1610413-A	1610413-EC	-	-	6 Retail	B
15"	1610415-A	-	-	-	6 Retail	B
25"	1610425-A	-	-	-	6 Retail	B

IMAGE	A.	B.	C.	OEM		
	HEIGHT	ANODIZED	E-COAT	BRITE DIP	PACK QUANTITY	ABYC
11"	3610411-A	3610411-EC	3610411-P	-	20 Bulk	B
13"	3610413-A	3610413-EC	3610413-P	-	20 Bulk	B
15"	3610415-A	-	3610415-P	-	20 Bulk	B
25"	3610425-A	-	-	-	20 Bulk	B

Retail packages are packed in clamshell with 4 color label  
 Hefty 1-3/4" diameter post and reinforcement ring.  
 Available in a variety of lengths and finishes.  
 Use with any KingPin™ seat mount (sold separately).  
 Use with any standard KingPin™ base (sold separately).



## THREADED FIXED HEIGHT POSTS

IMAGE	A.	B.	C.	RETAIL		
	HEIGHT	ANODIZED	E-COAT	BRITE DIP	PACK QUANTITY	ABYC
11"	1630411-A	-	-	-	6 Retail	B
13"	1630402-A	1630402-EC	-	-	6 Retail	B
15"	1630423-A	-	-	-	6 Retail	B
25"	1630415-A	-	-	-	6 Retail	B

IMAGE	A.	B.	C.	OEM		
	HEIGHT	ANODIZED	E-COAT	BRITE DIP	PACK QUANTITY	ABYC
9"	-	-	3630409-P	-	20 Bulk	B
11"	3630411-A	-	-	-	20 Bulk	B
13"	3630402-A	3630402-EC	3630402-P	-	20 Bulk	B
15"	3630423-A	-	3630423-P	-	20 Bulk	B
25"	3630414-A	-	-	-	20 Bulk	B

Retail packages are packed in clamshell with 4 color label  
 Hefty 1-3/4" diameter post and reinforcement ring.  
 Available in a variety of lengths and finishes.  
 Use with any KingPin™ seat mount (sold separately).  
 Use with any threaded KingPin™ base (sold separately).



## STAINLESS STEEL FIXED POSTS

IMAGE	HEIGHT	PART NUMBERS	POST	PIN	PACK QUANTITY	ABYC
A	13"	3610413-PSS	Brite Dip	Standard Stainless Steel	20 Bulk	B
B	13"	3630413-SS	Stainless Steel	Threaded Stainless Steel	20 Bulk	B

Hefty 1-3/4" diameter post and reinforcement ring.  
 Use with any KingPin™ seat mount (sold separately).  
 Use with any standard or threaded KingPin™ base (sold separately).



KINGPIN™ SERIES

## OFFSET POSTS

RETAIL IMAGE	PART NUMBER	HEIGHT	PIN	PACK QUANTITY	ABYC
A.	1610413-OSS	13"	Standard	6 Retail	B
B.	1630402-CSS	13"	Threaded	6 Retail	B

OEM IMAGE	PART NUMBER	HEIGHT	PIN	PACK QUANTITY	ABYC
A.	3610413-OSS	13"	Standard	20 Bulk	B
B.	3630402-CSS	13"	Threaded	20 Bulk	B

Retail packages are packed in clamshell with 4 color label

13" hefty 1-3/4" diameter stainless steel post with mild steel e-coat pin. Provides a full 5" of offset extension.

Use with any KingPin™ seat mount (sold separately).  
Use with any standard or threaded KingPin™ base (sold separately).



KingPin™ Posts are Rated ABYC Class H-31 B

KINGPIN™ SERIES

## STANDARD SQUARE STEEL BASES

RETAIL IMAGE	PART NUMBER	HEIGHT	MATERIAL	FINISH	BUSHING	PACK QUANTITY	ABYC
A.	1620001	7" x 7"	Stainless Steel	Satin	Nylon	6 Retail	B
C.	1620003	7" x 7" Offset	Stainless Steel	Satin	Nylon	6 Retail	B
E.	1620018	7" x 7"	Mild Steel	Black Krinkle	Nylon	6 Retail	B

OEM IMAGE	PART NUMBER	HEIGHT	MATERIAL	FINISH	BUSHING	PACK QUANTITY	ABYC
A.	3620001	7" x 7"	Stainless Steel	Satin	Nylon	20 pack	B
B.	3620001-P	7" x 7"	Stainless Steel	Polished	Nylon	20 pack	B
C.	3620003	7" x 7" Offset	Stainless Steel	Satin	Nylon	20 pack	B
D.	3620011	7" x 7"	Mild Steel	E-Coat	Nylon	20 pack	B
E.	3620018	7" x 7"	Mild Steel	Black Krinkle	Nylon	20 pack	B

Retail packages are packed in clamshell with 4 color label

Standard square bases, available in stainless steel or mild steel with a variety of finishes. 3" cup depth. Below the deck mount (requires a 2-1/2" hole in deck).

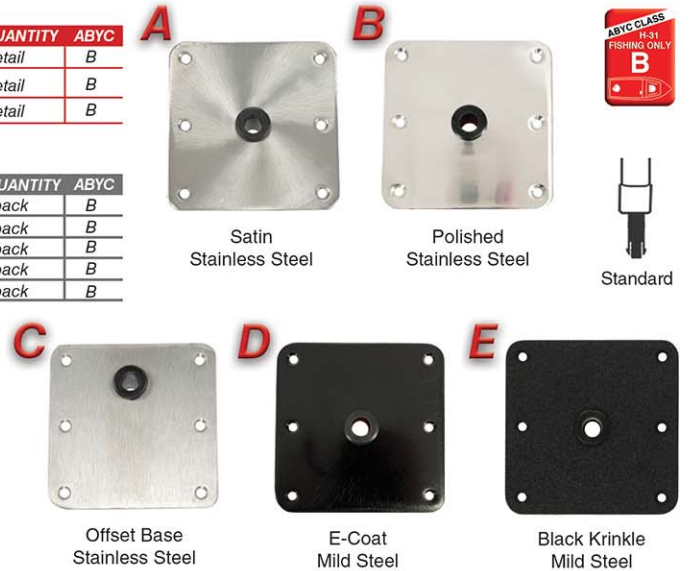
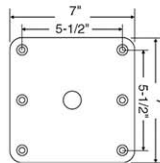

KingPin™ bases are Rated ABYC Class H-31 B

## STANDARD RECTANGULAR STEEL BASES

RETAIL IMAGE	PART NUMBER	BASE	MATERIAL	FINISH	BUSHING	PACK QUANTITY	ABYC
A.	1620004	6" x 8"	Stainless Steel	Satin	Nylon	6 Retail	B
B.	1620005	4" x 8"	Stainless Steel	Satin	Nylon	6 Retail	B

OEM IMAGE	PART NUMBER	BASE	MATERIAL	FINISH	BUSHING	PACK QUANTITY	ABYC
A.	3620004	6" x 8"	Stainless Steel	Satin	Nylon	6 Retail	B
B.	3620005	4" x 8"	Stainless Steel	Satin	Nylon	6 Retail	B
C.	3620005-P	4" x 8"	Stainless Steel	Polished	Nylon	6 Retail	B

Retail packages are packed in clamshell with 4 color label

Standard rectangular bases, available in stainless steel with a variety of finishes. 3" cup depth. Below the deck mount (requires a 2-1/2" hole in deck).

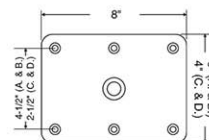

KingPin™ bases are Rated ABYC Class H-31 B

# KingPin™ Series

## THREADED SQUARE STEEL BASES

RETAIL IMAGE	PART NUMBER	BASE SIZE	MATERIAL	FINISH	BUSHING	PACK QUANTITY	ABYC
A.	1630001	7" x 7"	Stainless Steel	Satin	Nylon	6 Retail	B
C.	1630001-P	7" x 7"	Stainless Steel	Polished	Nylon	6 Retail	B
E.	1630003	7" x 7" Offset	Stainless Steel	Satin	Nylon	6 Retail	B

OEM IMAGE	PART NUMBER	BASE SIZE	MATERIAL	FINISH	BUSHING	PACK QUANTITY	ABYC
A.	3630001	7" x 7"	Stainless Steel	Stainless Steel	Nylon	20 Bulk	B
D.	3630001-PB	7" x 7"	Stainless Steel	Polished	Brass	20 Bulk	B
E.	3630003	7" x 7" Offset	Stainless Steel	Satin	Nylon	20 Bulk	B
B.	3630020	7" x 7"	Mild Steel	E-Coat	Nylon	20 Bulk	B
B.	3630020-NB	7" x 7"	Mild Steel	E-Coat	-	20 Bulk	B
F.	3630020-OS	7" x 7" Offset	Mild Steel	E-Coat	Nylon	20 Bulk	B
F.	3630020-OSNB	7" x 7" Offset	Mild Steel	E-Coat	-	20 Bulk	B

KingPin™ bases are Rated ABYC Class H-31 B

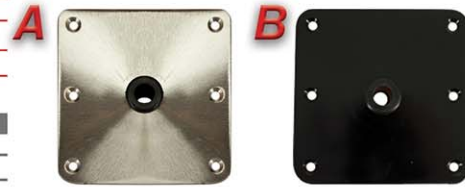

Satin Stainless Steel

E-Coat Mild Steel



Polished Stainless Steel

Polished Stainless Steel Brass Bushing



Satin, Offset Bushing Stainless Steel

E-Coat, Offset Bushing Mild Steel

Retail packages are packed in clamshell with 4 color label

Threaded square bases, available in polished or satin stainless steel, and mild steel with e-coat finish. 4" cup depth for use with threaded KingPin™ posts (sold separately). Below the deck mount (requires a 3-3/4" hole in deck). Nylon Bushing or NB = No Bushing.



Welded 3/4 x 10 stainless steel nut.

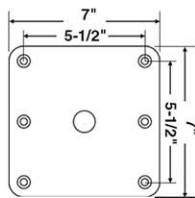

Threaded

## THREADED RECTANGULAR STEEL BASES

RETAIL IMAGE	PART NUMBER	BASE SIZE	MATERIAL	FINISH	BUSHING	PACK QUANTITY	ABYC
A.	1630004	6" x 8"	Stainless Steel	Satin	Nylon	6 Retail	B

OEM IMAGE	PART NUMBER	BASE SIZE	MATERIAL	FINISH	BUSHING	PACK QUANTITY	ABYC
A.	3630004	6" x 8"	Stainless Steel	Satin	Nylon	20 Pack	B
B.	3630004-BLK	6" x 8"	Mild Steel	Black Krinkle	Nylon	20 Pack	B
C.	3630004-EC	6" x 8"	Mild Steel	E-Coat	Nylon	20 Pack	B
D.	3630005	4" x 8"	Stainless Steel	Satin	Nylon	20 Pack	B
E.	3630005-PB	4" x 8"	Stainless Steel	Polished	Brass	20 Pack	B
F.	3630007-NB	3" x 4"	Stainless Steel	Satin	-	20 Pack	B
G.	3630019	7" x 10"	Stainless Steel	Satin	Nylon	20 Pack	B

KingPin™ bases are Rated ABYC Class H-31 B



Satin Stainless Steel

Black Krinkle Mild Steel



E-Coat Mild Steel

Satin Stainless Steel



Polished Stainless Steel

Satin Stainless Steel

Mill Finish Stainless Steel

Retail packages are packed in clamshell with 4 color label

Threaded rectangular bases, available in stainless steel or mild steel with a variety of finishes. 4" cup depth. Below the deck mount (requires a 3-3/4" hole in deck). Welded stainless steel nut for optimal support.

Nylon Bushing or NB = No Bushing.

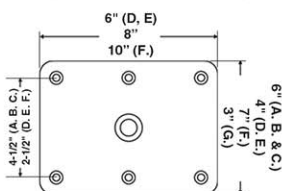

Welded 3/4 x 10 stainless steel nut.

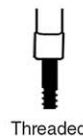

Threaded

## STANDARD SQUARE ALUMINUM BASE

RETAIL							
IMAGE	PART NUMBER	BASE SIZE	MATERIAL	FINISH	BUSHING	PACK QUANTITY	ABYC
A.	1620016	7" x 7"	Aluminum	Satin	Nylon	6 Retail	B

OEM							
IMAGE	PART NUMBER	BASE SIZE	MATERIAL	FINISH	BUSHING	PACK QUANTITY	ABYC
A.	3620016	7" x 7"	Aluminum	Satin	Nylon	20 Bulk	B

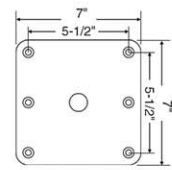

KingPin™ bases are Rated ABYC Class H-31 B



Retail packages are packed in clamshell with 4 color label

High-strength aluminum, satin finish, 3" cup depth. Below the deck mount (requires a 2-1/2" hole in deck). Use with any standard KingPin™ post (sold separately).



KINGPIN™ SERIES

## KINGPIN™ ROUND BASE

RETAIL								
IMAGE	PART NUMBER	BASE SIZE	MATERIAL	PIN	FINISH	BUSHING	PACK QUANTITY	ABYC
A.	1620017-S	8"	Aluminum	Standard	Satin	Nylon	6 Retail	B

OEM								
IMAGE	PART NUMBER	BASE SIZE	MATERIAL	PIN	FINISH	BUSHING	PACK QUANTITY	ABYC
A.	3620017-SB	8"	Aluminum	Standard	Satin	Brass	20 Bulk	B
C.	3620024	5" x 7" Oval	Stainless Steel	Standard	Polished	Nylon	20 Bulk	B
C.	3630024	5" x 7" Oval	Stainless Steel	Threaded	Polished	Nylon	20 Bulk	B
B.	3630025	4"	Stainless Steel	Threaded	Polished	Nylon	20 Bulk	B
B.	3620025	4"	Stainless Steel	Standard	Polished	Nylon	20 Bulk	B



KingPin™ bases are Rated ABYC Class H-31 B



Retail packages are packed in clamshell with 4 color label

Round bases, available in satin or polished finish. Below the deck mount, requires a 2-1/2" hole below deck.

Use with any standard or threaded KingPin™ post (sold separately).

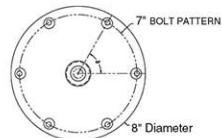

## KINGPIN™ ACCESSORIES

RETAIL			
IMAGE	PART NUMBER	DESCRIPTION	PACK QUANTITY
A.	2100026	1-3/4" Stowable post clips	6 Retail
B.	2100032	Taper-Lock™ Adapter	6 Retail
C.	2100055	Nylon KingPin™ Bushing	6 Retail
D.	2100077	Brass KingPin™ Bushing	6 Retail
E.	2100094	Base Socket Cover	6 Retail
F.	2100175	KingPin™ Retention Clip	6 Retail

OEM			
IMAGE	PART NUMBER	DESCRIPTION	PACK QUANTITY
C.	2100055-M	Nylon KingPin™ Bushing	120 Bulk
G.	3620760	Splash Guard for KingPin™ Bases	20 Bulk



Inserts into Taper-Lock™ base to accept KingPin™ pedestals.



Brass replacement bushing for KingPin™ bases



Base socket cover



Plastic KingPin™ Retention Clip



Installed on base below deck to prevent water from entering into compartments below



# Taper-Lock™ Series

## ABOUT TAPER-LOCK™

Springfield Marine introduced the Taper-Lock™ pedestal system in 1982. Since then, over One Million units have been sold!

The design of the Taper-Lock™ provides the most stable, secure, and versatile systems in the industry. The slight taper of the high-strength composite bushing matches the corresponding taper in the socket of the pedestal base, thus creating a snug, secure fit that can be disengaged as needed. To prevent turning freely, the Taper-Lock™ bushing features a locking tab which also helps hold the pedestal firmly in place.

Ideal for fishing boats, the Taper-Lock™ has been widely used by many of the top-name boat builders in the industry for many years.

PACKAGES • SEAT MOUNTS • PEDESTALS • BASES • ACCESSORIES

Use On



Pontoon Boats



Fishing Boats



PRODUCTS IN THE TAPER-LOCK™ SERIES ARE  
DESIGNED FOR RECREATIONAL USE ONLY



[www.springfieldgrp.com](http://www.springfieldgrp.com)





## 2-PIECE POST SETS

RETAIL IMAGE	PART NUMBER	DESCRIPTION	DIAMETER	PACK QUANTITY	ABYC
A.	1600420	Hi-Lo 2-Piece Package	2-3/8"	1 Retail	B
B.	1600607	Non-Locking 2-Piece Package	2-3/8"	1 Retail	AP
C.	1600607-L	Locking 2-Piece Package	2-3/8"	1 Retail	AD

2-Piece Sets Are Rated  
ABYC Class H-31 AD, AP, And B



**2 - Piece Hi-Lo set (A.) includes the following parts:**

- Taper-Lock™ Hi-Lo polished post (#1600406)
- Taper-Lock™ Hi-Lo swivel (#1600205)

Use with any Taper-Lock™ base (sold separately)  
16" from deck to top of swivel.

**2 - Piece set (B. & C.) includes the following parts:**

- Taper-Lock™ 13" Anodized post (#1600406)
  - Taper-Lock™ locking (C.) or non-locking (B.) 2-3/8" swivel
- Use with any Taper-Lock™ base (sold separately)

This Hi-Lo system allows upright seating while fishing, or compact storage and increased driver visibility while the boat is underway.



TAPER-LOCK™ SERIES

## POWER-RISE STAND-UP POSTS

RETAIL IMAGE	PART NUMBER	DESCRIPTION	DIAMETER	ADJUSTS	PACK QUANTITY	ABYC
A.	1602016	Stand-Up Post & Mount	2-3/8"	22-1/2" to 29-1/2"	1 Retail	B

Taper-Lock™ Posts Are  
Rated ABYC Class H-31 B



Retail packages are packed in clamshell with 4 color label  
Power Rise Stand-Up Taper-Lock™ Post  
Adjusts from 22-1/2" to 29-1/2" and rotates 360°.  
Power-Rise stand up Taper-Lock™ post.

Use with any Taper-Lock™ base.

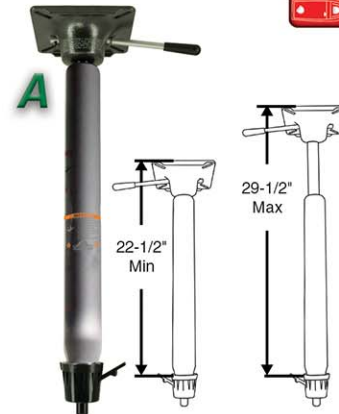
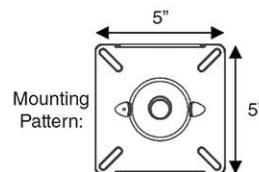

## POWER-RISE SIT DOWN POSTS

RETAIL IMAGE	PART NUMBER	DESCRIPTION	DIAMETER	ADJUSTS	PACK QUANTITY	ABYC
A.	1601002-L	Locking Pedestal	2-3/8"	13-1/2" to 20"	1 Retail	B

Taper-Lock™ Posts Are  
Rated ABYC Class H-31 B



Retail packages are packed in clamshell with 4 color label  
Power-Rise sit down Taper-Lock™ post.  
Adjusts from 13.5" to 20" and rotates 360°.  
Use with any Taper-Lock™ base (sold separately)  
Cam prevents free spinning while trailering  
(on locking pedestals).

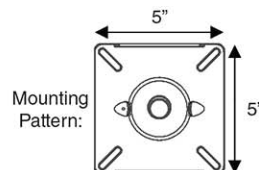

# Taper-Lock™ Series

## POWER-RISE STAND-UP PACKAGES

RETAIL IMAGE	PART NUMBER	DESCRIPTION	ADJUSTS	PACK QUANTITY	ABYC
A.	1601037	Power-Rise Stand-Up post package	25-1/2" to 32-1/2"	1 Retail	B

Retail packed in box with 4 color label

Power-Rise set include the following parts:

- Power-Rise Stand-Up Post
- Quik-Tilt seat mount (#1615254-EC)
- Gray Pro Stand-Up seat (#1040213)

Use with any Taper-Lock™ base (sold separately)



Use as seat or leaning post  
 adjusts from 25-1/2" to 32-1/2"  
 (add 2-3/4" height for seat mount)  
 (add 4-3/4" height for seat thickness)  
 Rotates 360° Quik-Tilt seat mount tilts  
 in 4 snap-in angles (0°, 30°, 60°, 90°)



Taper-Lock™ Packages Are  
 Rated ABYC Class H-31 B

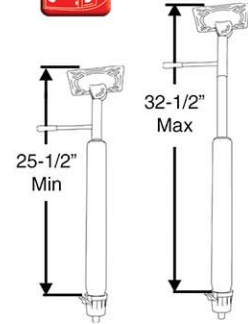

TAPER-LOCK™ SERIES

## MANUAL ADJUSTABLE STAND-UP PACKAGES

RETAIL IMAGE	PART NUMBER	ADJUSTS	DIAMETER	PACK QUANTITY	ABYC
A.	1603824	21" to 31"	2-3/8"	1 Retail	B
A.	1603825	13" to 16"	2-3/8"	1 Retail	B

OEM IMAGE	PART NUMBER	ADJUSTS	DIAMETER	PACK QUANTITY	ABYC
A.	3603825-NS	13" to 16"	2-3/8"	10 Bulk	B

(3603825-NS and Swivel sold separately)

2-Piece sets include the following parts:

- 2-3/8" Manual adjustable post (with posi-lock system)
- Trac-Lock™ non-locking 2-3/8" swivel (#1100031-1)

Use with any Taper-Lock™ base (sold separately)



Taper-Lock™ Posts are  
 Rated ABYC Class H-31 B

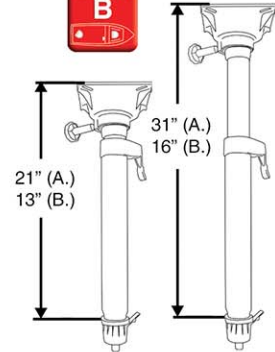

## TRAC-LOCK™ SEAT MOUNT FOR TAPER-LOCK™

RETAIL IMAGE	PART NUMBER	DESCRIPTION	POST MOUNT	PACK QUANTITY	ABYC
A.	1100031-1	Non-locking Trac-Lock™ seat mount	2-3/8"	6 Retail	AP
B.	1100031-L1	Locking Trac-Lock™ seat mount	2-3/8"	6 Retail	AD

RETAIL IMAGE	PART NUMBER	DESCRIPTION	POST MOUNT	PACK QUANTITY	ABYC
A.	3100031-1	Non-locking Trac-Lock™ seat mount	2-3/8"	20 Bulk	AP
B.	3100031-L1	Locking Trac-Lock™ seat mount	2-3/8"	20 Bulk	AD

Retail packages are packed clamshell with 4 color label

High-strength aluminum with powder coat finish.  
 Rotates 360°, 2-3/8" post mount with bushing for  
 snug fit. Locking with centrally located locking  
 handle, or non-locking swivel.  
 Adds 3/4" to height of pedestal.

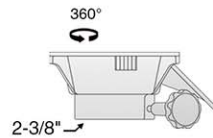
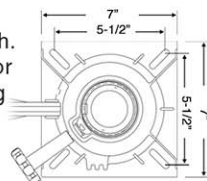

Taper-Lock™ Swivels are rated  
 ABYC Class H-31 AD & AP



## HI-LO SWIVEL

RETAIL IMAGE	PART NUMBER	DESCRIPTION	PACK QUANTITY	ABYC
A.	1600205	Hi-Lo Swivel seat mount	6 Retail	B

Hi-Lo Seat Mounts Are Rated  
ABYC Class H-31 B

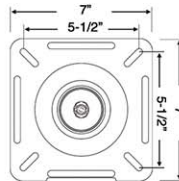

Retail packages are packed in clamshell with 4 color label

Aluminum cast powder coat finish.  
Use with any Taper-Lock™ Hi-Lo post (sold separately).  
Swivel adds 4" to height of post.

TAPER-LOCK™ SERIES

## FIXED HEIGHT HI-LO POSTS

RETAIL IMAGE	PART NUMBER	FIXED HEIGHT	DIAMETER	PACK QUANTITY	ABYC
A.	1600409	9"	2-3/8"	6 Retail	B
A.	1600406	13"	2-3/8"	6 Retail	B

Hi-Lo Posts Are Rated  
ABYC Class H-31 B



Anodized

RETAIL IMAGE	PART NUMBER	FIXED HEIGHT	DIAMETER	PACK QUANTITY	ABYC
A.	3600409	9"	2-3/8"	20 Bulk	B
A.	3600406	13"	2-3/8"	20 Bulk	B
B.	3600413	12"	2-3/8"	20 Bulk	B

Retail packages are packed in clamshell with 4 color label

Use with seat mount #1600205 (sold separately)  
Use with any Taper-Lock™ base (sold separately).  
Contact us for additional post lengths.

## FIXED HEIGHT POSTS

RETAIL IMAGE	PART NUMBER	DESCRIPTION	FIXED HEIGHT	PACK QUANTITY	ABYC
A.	1600610	Non-locking post	13"	6 Retail	AP
A.	1600611	Non-locking post	15"	6 Retail	AD

Fixed Height Posts Are Rated  
ABYC Class H-31 AD & AP



Non-Locking

Locking



Retail packages are packed in clamshell with 4 color label

Locking or non-locking 2-3/8" posts with brite dip finish.  
Use with locking or non-locking Trac-Lock™ swivel (sold separately).  
Use with any Taper-Lock™ base (sold separately).  
Contact us for additional post lengths.

# Taper-Lock™ Series

## 9" ALUMINUM BASES

IMAGE	PART NUMBER	SIZE	SHAPE	FINISH	PACK QUANTITY
B.	1600003	9"	Round Base	Satin	6 Retail
C.	1600005	9"x 7"	Flat side base	Satin	6 Retail
D.	1600008	9"x 5-1/8"	Double flat side	Satin	6 Retail
E.	1600010	9"	Round surface mount	Satin	6 Retail

IMAGE	PART NUMBER	SIZE	SHAPE	FINISH	PACK QUANTITY
A.	3600002-AB	9"	Round Base	Anodized	20 Bulk
B.	3600003	9"	Round Base	Satin	20 Bulk
C.	3600005	9"x 7"	Flat side base	Satin	20 Bulk
D.	3600008	9"x 5-1/8"	Double flat side	Satin	20 Bulk
E.	3600010	9"	Round surface mount	Satin	20 Bulk

High-strength aluminum to withstand all conditions. Below the deck mount -- requires a 3-1/2" hole in deck. 8" mounting hole pattern. Flat side bases for limited space applications. Use with any Taper-Lock™ post (sold separately).

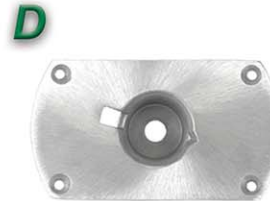
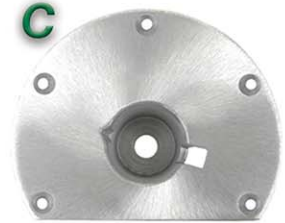
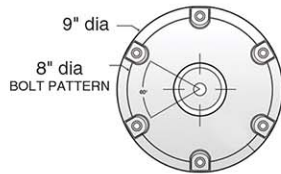

## TAPER-LOCK™ ACCESSORIES

IMAGE	PART NUMBER	DESCRIPTION	PACK QUANTITY
A.	2100031	Power pedestal repair kit	6 Pack
B.	2171003	Seat swivel bushing	6 Pack
C.	2171004	Post bottom bushing	6 Pack
D.	2171032	2-3/8" Hi-Lo bushing	6 Pack
E.	2171035	2" Hi-Lo bushing	6 Pack

### Power Pedestal repair kit



Replacement bushing for Taper-Lock™ swivels



Replacement bushing for Taper-Lock™ posts



Composite bushing for 2-3/8" Hi-Lo posts



Bushing for Hi-Lo fits 2" Posts



# ABOUT PLUG-IN™

Springfield Marine's removable pedestal series includes the Plug-In™. Stainless steel hardware, high-strength aluminum, and engineering grade plastics are used throughout to ensure the highest quality of all parts. High strength keyed Aluminum Anodized post fits into base with inner and outer bushing for clean look and sturdy function.

The Plug-In™ series features a unique notched and keyed design that provides security against rotation in the base and seat mount. Once the post is securely engaged into the base, the Plug-In™ provides a safe and stable seating system for your comfort.

This strong and sturdy interlocking design has continued to make the Plug-In™ series an ongoing popular choice of removable pedestal systems for boats used in punishing freshwater & Saltwater conditions.



PACKAGES • SEAT MOUNTS • PEDESTALS • BASES • ACCESSORIES

Use On:



Pontoon Boats



Bow Rider



Fishing Boats



PRODUCTS IN THE PLUG-IN™ SERIES ARE DESIGNED FOR RECREATIONAL USE ONLY

PLUG-IN™ SERIES

# Plug-In™ Series

## 2-3/8" 3-PIECE PEDESTAL SETS

3-Piece Packages Are Rated  
ABYC Class H-31 AD & B



RETAIL IMAGE	PART NUMBER	DESCRIPTION	HEIGHT	PACK QUANTITY	ABYC
A.	1300709-HL1	Hi-Lo 3-Piece Packages	9"	1 Retail	B
A.	1300712-HL1	Hi-Lo 3-Piece Packages	12"	1 Retail	B
A.	1300715-HL1	Hi-Lo 3-Piece Packages	15"	1 Retail	B
B.	1300709-L1	Locking 3-Piece Packages	9"	1 Retail	AD
B.	1300712-L1	Locking 3-Piece Packages	12"	1 Retail	AD
B.	1300715-L1	Locking 3-Piece Packages	15"	1 Retail	AD



Retail packages are packed in box with 4 color label

Hi-Lo 3-Piece set (A.) includes the following parts:

- Plug-In™ Hi-Lo swivel seat mount (#1312700)
- Plug-In™ Hi-Lo fixed height post, anodized finish
- Plug-In™ 9" diameter base, satin finish (#1300751-1)

Locking 3-Piece set (B.) includes the following parts:

- Trac-Lock™ locking swivel seat mount (#1100031-L1)
- Plug-In™ fixed height post, anodized finish
- Plug-In™ 9" diameter base, satin finish (#1300750-1)

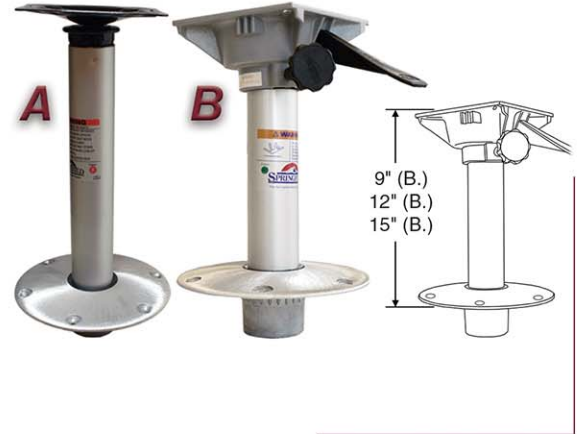
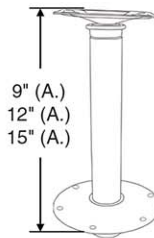

PLUG-IN™ SERIES

## POWER-RISE STAND-UP POSTS

Plug-In™ Posts Are  
Rated ABYC Class H-31 B



RETAIL IMAGE	PART NUMBER	DESCRIPTION	ADJUSTS	PACK QUANTITY	ABYC
A.	1301037	3-Piece Power-Rise Stand-Up Package	25-1/2" to 32-1/2"	1 Retail	B
B.	1301038	2-Piece Power-Rise Stand-Up Package	25-1/2" to 32-1/2"	1 Retail	B

3-Piece set (A.) includes the following parts:

- Power-Rise Stand-Up post (#1303013)
- Quik-Tilt seat mount (#1615254-EC)
- Gray Pro Stand-Up Seat (#1040213)

Retail packed in box with 4 color label

2-Piece set (B.) includes the following parts:

- Power-Rise Stand-Up post (#1303013)
- Quik-Tilt seat mount (#1615254-EC)

High-strength aluminum pedestal.  
Adjusts from 25-1/2" to 32-1/2".  
Fits any 2-3/8" Plug-In™ base (sold separately).



## POWER-RISE AIR-RIDE POSTS

Plug-In™ Posts Are  
Rated ABYC Class H-31 B



RETAIL IMAGE	PART NUMBER	DESCRIPTION	ADJUSTS	PACK QUANTITY	ABYC
A.	1300901	Locking air-ride posts	14-1/4" to 21"	1 Retail	B
B.	1300902	Locking air-ride posts	22-1/4" to 29-1/2"	1 Retail	B

OEM IMAGE	PART NUMBER	DESCRIPTION	ADJUSTS	PACK QUANTITY	ABYC
A.	3300900	Locking air-ride posts	12-3/4" to 17-3/4"	2 Bulk	B
A.	3300901	Locking air-ride posts	14-1/4" to 21"	2 Bulk	B
A.	3300902-AS	Locking air-ride posts w/sleeve	22-3/4" to 29"	2 Bulk	B

Retail packages are packed in clamshell with 4 color label

Posts can be locked in position to prevent rotating or unlocked to rotate freely.  
Provides safe, stable seating. Fits any 2-3/8" Plug-In™ base (sold separately).

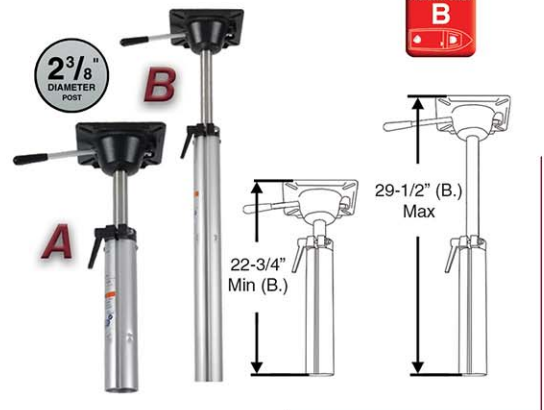
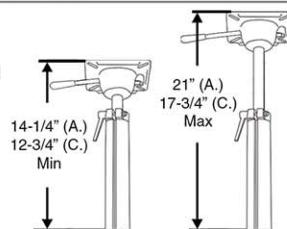

## POWER-RIDE AIR-RIDE PACKAGE

Plug-In™ Packages Are Rated  
ABYC Class H-31 AD & AP



RETAIL					
IMAGE	PART NUMBER	DESCRIPTION	ADJUSTS	PACK QUANTITY	ABYC
A.	1300601	Locking Trac-Lock™ Swivel	13-1/4" to 17-1/4"	1 Retail	AD
B.	1300601-AP	Non-locking Trac-Lock™ Swivel	13-1/4" to 17-1/4"	1 Retail	AP
C.	1300650-L	Plug-In™ Air Ride Ped w/ Slide	13-3/4" to 17-3/4"	1 Retail	AD

OEM					
IMAGE	PART NUMBER	DESCRIPTION	ADJUSTS	PACK QUANTITY	ABYC
A.	3300601	Locking Trac-Lock™ Swivel	13-1/4" to 17-1/4"	2 Bulk	AD
B.	3300601-AP	Non-locking Trac-Lock™ Swivel	13-1/4" to 17-1/4"	2 Bulk	AP

Retail packages are packed in box with 4 color label

High-strength aluminum post.  
Includes Trac-Lock™ locking or non-locking air-ride swivel.  
Fits any 2-3/8" Plug-In™ base (sold separately).



## TRACK-LOCK™ SEAT MOUNT FOR PLUG-IN™

Trac-Lock™ Swivels Are Rated  
ABYC Class H-31 AD & AP



RETAIL					
IMAGE	PART NUMBER	DESCRIPTION	PACK QUANTITY	ABYC	
A.	1100031-1	Non-locking 2-3/8" Trac-Lock™ Swivel	6 Retail	AP	
B.	1100031-L1	Locking 2-3/8" Trac-Lock™ Swivel	6 Retail	AD	

RETAIL					
IMAGE	PART NUMBER	DESCRIPTION	PACK QUANTITY	ABYC	
A.	3100031-1	Non-locking 2-3/8" Trac-Lock™ Swivel	20 Bulk	AP	
B.	3100031-L1	Locking 2-3/8" Trac-Lock™ Swivel	20 Bulk	AD	

Retail packages are packed in clamshell with 4 color label

High-strength aluminum with powder coat finish.  
Rotates 360°, 2-3/8" post mount with bushing  
for snug fit. Locking with centrally located  
locking handle, or non-locking swivel.  
Adds 3/4" to height of pedestal.

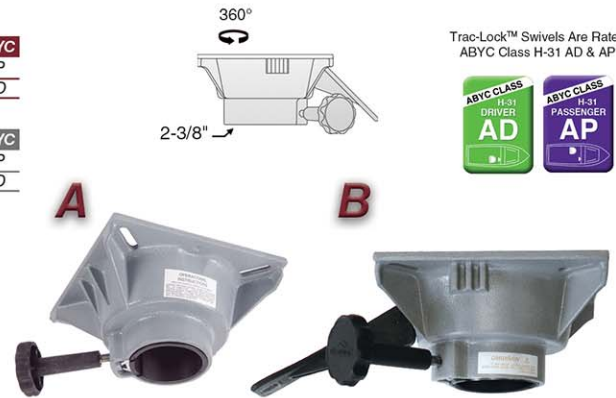
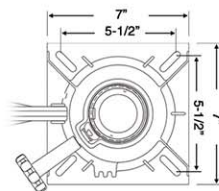

## HI-LO PLUG-IN™ SEAT MOUNT

Plug-In™ Seat Mounts Are  
Rated ABYC Class H-31 B



RETAIL					
IMAGE	PART NUMBER	DESCRIPTION	PIN	PACK QUANTITY	ABYC
A.	1312701	Plug-In™ Hi-Lo Swivel	5"	6 Retail	AD

OEM					
IMAGE	PART NUMBER	DESCRIPTION	PIN	PACK QUANTITY	ABYC
A.	3312701	Plug-In™ Hi-Lo Swivel	5"	20 Bulk	AD
B.	3312701-PP	Plug-In™ Hi-Lo Swivel	5"	20 Bulk	AD

Retail packages are packed in clamshell with 4 color label  
Hi-Lo seat swivel adds 1-3/4" to height of post.  
Pin fits into Hi-Lo post for seating,  
or into Hi-Lo base for compact storage.



Seating Position



Storage Position

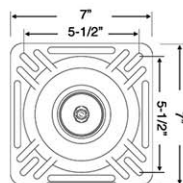

PLUG-IN™ SERIES

# Plug-In™ Series

## 2-3/8" LOCKING FIXED HEIGHT POSTS

RETAIL IMAGE	PART NUMBER	DESCRIPTION	DIAMETER	HEIGHT	PACK QUANTITY	ABYC
A.	1300709	Locking post	2-3/8"	9"	6 Retail	AD
A.	1300712	Locking post	2-3/8"	12"	6 Retail	AD
A.	1300713	Locking post	2-3/8"	13"	6 Retail	AD
A.	1300715	Locking post	2-3/8"	15"	6 Retail	AD

Plug-In™ Posts Are Rated ABYC Class H-31 AD



OEM IMAGE	PART NUMBER	DESCRIPTION	DIAMETER	HEIGHT	PACK QUANTITY	ABYC
A.	3300709	Locking post	2-3/8"	9"	20 Pack	AD
A.	3300710	Locking post	2-3/8"	10"	20 Pack	AD
A.	3300712	Locking post	2-3/8"	12"	20 Pack	AD
A.	3300713	Locking post	2-3/8"	13"	20 Pack	AD
A.	3300714	Locking post	2-3/8"	14"	20 Pack	AD
A.	3300715	Locking post	2-3/8"	15"	20 Pack	AD
A.	3300728	Locking post	2-3/8"	28"	20 Pack	AD

Retail packages are packed in clamshell with 4 color label

Heights are from top of swivel to deck, when post is installed.  
Anodized to withstand all conditions.  
Fits into any 2-3/8" Plug-In™ base (sold separately).



PLUG-IN™ SERIES

## 2-3/8" LOCKING POST WITH LATCH

OEM IMAGE	PART NUMBER	DESCRIPTION	DIAMETER	HEIGHT	FINISH	PACK QUANTITY	ABYC
A.	3310708-L	Locking Post With Latch	2-3/8"	8.5"	Anodized	20 Bulk	AD
A.	3310709-L	Locking Post With Latch	2-3/8"	9"	Anodized	20 Bulk	AD
A.	3310710-L	Locking Post With Latch	2-3/8"	10"	Anodized	20 Bulk	AD
A.	3310712-L	Locking Post With Latch	2-3/8"	12"	Anodized	20 Bulk	AD
A.	3310715-L	Locking Post With Latch	2-3/8"	15"	Anodized	20 Bulk	AD
A.	3310725-L	Locking Post With Latch	2-3/8"	25"	Anodized	20 Bulk	AD

Plug-In™ Posts Are Rated ABYC Class H-31 AD



Latch safely secures posts to base.  
Heights are from top of swivel to deck, when post is installed.  
Fits into any Plug-In™ base (sold separately).



## 2-3/8" HI-LO POSTS

RETAIL IMAGE	PART NUMBER	DESCRIPTION	DIAMETER	HEIGHT	FINISH	PACK QUANTITY	ABYC
A.	1304012-HL	2-3/8" Hi-Lo post	2-3/8"	12"	Anodized/Aluminum	6 Retail	B
A.	1304015-HL	2-3/8" Hi-Lo post	2-3/8"	15"	Anodized/Aluminum	6 Retail	B

Plug-In™ Posts Are Rated ABYC Class H-31 B



OEM IMAGE	PART NUMBER	DESCRIPTION	DIAMETER	HEIGHT	FINISH	PACK QUANTITY	ABYC
A.	3300709-HL	2-3/8" Hi-Lo post	2-3/8"	9"	Anodized/Aluminum	20 Bulk	B
A.	3300712-HL	2-3/8" Hi-Lo post	2-3/8"	12"	Anodized/Aluminum	20 Bulk	B
A.	3300713-HL	2-3/8" Hi-Lo post	2-3/8"	13"	Anodized/Aluminum	20 Bulk	B
A.	3300715-HL	2-3/8" Hi-Lo post	2-3/8"	15"	Anodized/Aluminum	20 Bulk	B
A.	3300728-HL	2-3/8" Hi-Lo post	2-3/8"	28"	Anodized/Aluminum	20 Bulk	B

Retail packages are packed in clamshell with 4 color label

Available in a variety of heights with high-strength anodized aluminum finish.  
Heights are from top of swivel to deck, when post is installed.  
Use with Plug-In™ Hi-Lo seat mount (sold separately).  
Use with 2-3/8" Plug-In™ bases (sold separately).

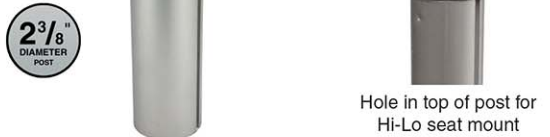

Hole in top of post for Hi-Lo seat mount



## ROUND BASES

RETAIL						
IMAGE	PART NUMBER	DESCRIPTION	DIAMETER	SIZE	FINISH	PACK QUANTITY
A.	1300750-1	Base	2-3/8"	9"	Satin	6 Retail
B.	1300750-A1	Base	2-3/8"	9"	Anodized	6 Retail
C.	1300751-1	Hi-Lo Base	2-3/8"	9"	Satin	6 Retail

OEM						
IMAGE	PART NUMBER	DESCRIPTION	DIAMETER	SIZE	FINISH	PACK QUANTITY
A.	3300750-1	Base	2-3/8"	9"	Satin	20 Bulk
B.	3300750-A1	Base	2-3/8"	9"	Anodized	20 Bulk
C.	3300751-1	Hi-Lo Base	2-3/8"	9"	Satin	20 Bulk
D.	3300764-PP1	Base	2-3/8"	5.5"	Stainless Steel	20 Bulk

Retail packages are packed in clamshell with 4 color label

Below the deck mount (requires a 3-3/4" hole in deck).  
Use with any 2-3/8" Plug-In™ post (sold separately).

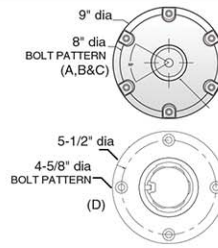

## FLAT SIDED ALUMINUM BASES

RETAIL				
IMAGE	PART NUMBER	DESCRIPTION	FINISH	PACK QUANTITY
A.	1300750-L1	Left Flat Sided Base	Satin	6 Retail
B.	1300750-R1	Right Flat Sided Base	Satin	6 Retail

OEM				
IMAGE	PART NUMBER	DESCRIPTION	FINISH	PACK QUANTITY
A.	3300750-L1	Left Flat Sided Base	Satin	20 Bulk
B.	3300750-R1	Right Flat Sided Base	Satin	20 Bulk
C.	3300750-D1	Double Flat Sided Base	Satin	20 Bulk
A.	3300750-AL1	Left Flat Sided Base	Anodized	20 Bulk
B.	3300750-AR1	Right Flat Sided Base	Anodized	20 Bulk
C.	3300750-AD1	Double Flat Sided Base	Anodized	20 Bulk

Retail packages are packed in clamshell with 4 color label

- Left Flat (A.): 9" x 7", flat side is on same side as notch
- Right Flat (B. & C.): 9" x 7", flat side is on opposite side as notch
- Dbl Flat (C.): 9" x 5-1/4", both sides are flat

Use with any 2-3/8" Plug-In™ post (sold separately).

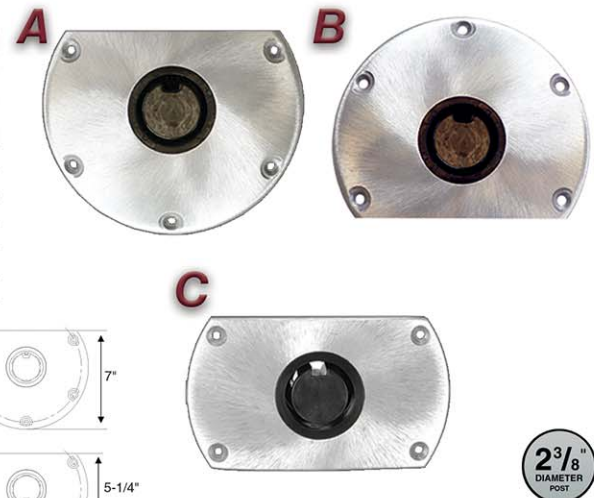
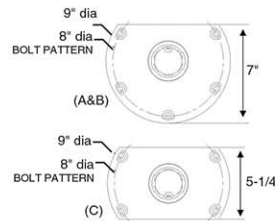

## SQUARE AND RECTANGLE BASES

RETAIL					
IMAGE	PART NUMBER	MATERIAL	SIZE	FINISH	PACK QUANTITY
A.	1300754-1	Stainless Steel	7" X 7"	Satin	1 Retail

OEM					
IMAGE	PART NUMBER	MATERIAL	SIZE	FINISH	PACK QUANTITY
B.	3300753-1	Mild Steel	7" X 7"	E-Coat	20 Bulk
C.	3300752-D	Stainless Steel	5" X 7"	E-Coat / Satin	20 Bulk
D.	3300753-K1	Mild Steel	7" X 7"	Black Krinkle	20 Bulk
A.	3300754-1	Stainless Steel	7" X 7"	Satin	20 Bulk
E.	3300757-D1	Mild Steel	5" X 7"	E-Coat	20 Bulk
F.	3300758-1	Stainless Steel	7" X 7"	Mill	20 Bulk
G.	3300759-PP1	Stainless Steel	7" X 7"	Polished	20 Bulk

Retail packages are packed in clamshell with 4 color label

Made of stainless steel or mild steel.  
Below the deck mount (requires a 3-3/4" hole in deck).  
Suitable for above or under carpet applications.  
Use with any 2-3/8" Plug-In™ post. (sold separately).

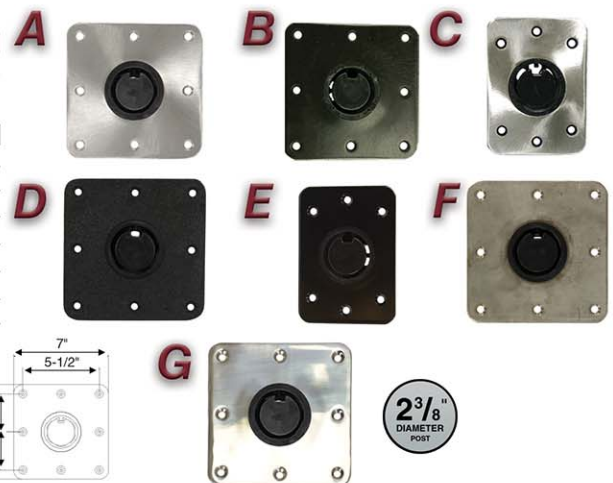
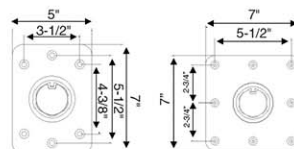

# Plug-In™ Series

## 2-7/8" TRAC-LOCK™ SWIVEL

RETAIL IMAGE	PART NUMBER	DESCRIPTION	DIAMETER	PACK QUANTITY	ABYC
A.	1100021-L1	Locking Trac-Lock™ Swivel	2-7/8"	6 Retail	AD

OEM IMAGE	PART NUMBER	DESCRIPTION	DIAMETER	PACK QUANTITY	ABYC
A.	3100021-L1	Locking Trac-Lock™ Swivel	2-7/8"	20 Bulk	AD

High-strength aluminum with powder coat finish.  
Post mount with bushing for snug fit.  
Locking with centrally located locking handle.

2-7/8" Trac-Lock™ Are Rated ABYC Class H-31 AD

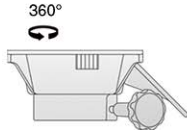

## 2-7/8" LOCKING FIXED HEIGHT POSTS

OEM IMAGE	PART NUMBER	DESCRIPTION	DIAMETER	HEIGHT	PACK QUANTITY	ABYC
A.	3301809	Locking Post	2-7/8"	9"	20 Bulk	AD
B.	3301812	Locking Post	2-7/8"	12"	20 Bulk	AD
C.	3301818	Locking Post	2-7/8"	18"	20 Bulk	AD

Anodized finish to withstand all conditions.  
Use with Trac-Lock™ locking swivel (sold separately). Fits into 2-7/8" Plug-In™ Base (sold separately). Heights are from top of swivel to deck, when post is installed.

Plug-In™ Posts Are Rated ABYC Class H-31 AD



PLUG-IN™ SERIES

## 9" ROUND 2-7/8" BASE

OEM IMAGE	PART NUMBER	DESCRIPTION	DIAMETER	FINISH	PACK QUANTITY	ABYC
A.	3300850-A1	Round Plug-In™ Base	2-7/8"	Anodized	20 Bulk	AD

2-7/8" Plug-In™ Bases Are Rated ABYC Class H-31 AD

High-strength aluminum, with anodized finish.  
Fits any 2-7/8" Plug-In™ post (sold separately).

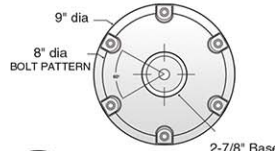

## PLUG-IN™ ACCESSORIES

RETAIL IMAGE	PART NUMBER	DESCRIPTION	PACK QUANTITY
A.	3300760	2-3/8" Splash Guard	20 Bulk
B.	3300766	2-3/8" Hi-Lo Replacement Bushing	20 Bulk



2-3/8" aluminum splash guard.



2-3/8" Hi-Lo replacement bushing.

## ABOUT THREAD-LOCK™

Springfield Marine originally introduced the Thread-Lock™ to be used as a table system. Soon we adapted our post-style grill to use the same attachment as the table.

The success of those two products made way for the redesign of the post and base for use as a seating system. A locking mechanism was added to the seat post to provide a secure and wobble free experience in both fishing models as well as underway models.

Thread-Lock's™ interchangeable parts allow the seating base to be used with the grill or table. The perfect base for a fishing deck... simply remove the seating post, install the grill or table, and enjoy. However, the seat post will not fit into the table base.

With the Thread-Lock™ system, attaching the post to the base is as easy as twisting in a light bulb. And the locking collar gives you peace of mind that your post stays on the base... safe and secure.



Use On:



Pontoon Boats



PACKAGES • SEAT MOUNTS • PEDESTALS • BASES • ACCESSORIES

THREAD-LOCK™ SERIES

PRODUCTS IN THE THREAD-LOCK™ SERIES ARE DESIGNED FOR RECREATIONAL USE ONLY

 [www.springfieldgrp.com](http://www.springfieldgrp.com) 

# Thread-Lock™ Series

## 3-PIECE PEDESTAL PACKAGE

RETAIL					
IMAGE	PART NUMBER	DESCRIPTION	UNIT HEIGHT	PACK QUANTITY	ABYC
A.	1793313	3-piece set (for use underway)	14"	1 Retail	AP

Retail packages are packed in clamshell with 4 color label

3-Piece set (B.) includes the following parts:

- Thread-Lock™ 13" fixed height post (#3793013-A)
- Trac-Lock™ non-locking swivel seat mount (#1100031-1)
- Thread-Lock™ 9" base (#3790001-SL)



A

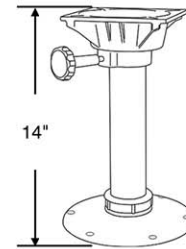

3-Piece Sets Are Rated  
ABYC Class H-31 AP & B



## TRAC-LOCK™ SEAT MOUNT FOR THREAD-LOCK™

RETAIL					
IMAGE	PART NUMBER	DESCRIPTION	DIAMETER	PACK QUANTITY	ABYC
A.	1100031-1	Non-locking seat mount	2-3/8"	6 Retail	AP

OEM					
IMAGE	PART NUMBER	DESCRIPTION	DIAMETER	PACK QUANTITY	ABYC
A.	3100031-1	Non-locking seat mount	2-3/8"	20 Bulk	AP

Retail packages are packed in clamshell with 4 color label

High-strength aluminum with powder coat finish.  
Use with 2-3/8" Fixed height posts (for underway).  
Swivel rotates 360° and adds 3/4" to height of pedestal.

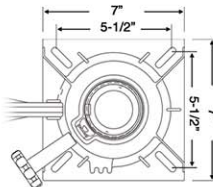

A

Trac-Lock™ Seat Mounts Are  
Rated ABYC Class H-31 AP



## KINGPIN™ SEAT MOUNT FOR THREAD-LOCK™

RETAIL					
IMAGE	PART NUMBER	DESCRIPTION	FINISH	PACK QUANTITY	ABYC
A.	1615204-EC	Seat mount, No spring	E-Coat	6 Retail	B

OEM					
IMAGE	PART NUMBER	DESCRIPTION	FINISH	PACK QUANTITY	ABYC
A.	3615204-EC	Seat mount, No spring	E-Coat	20 Bulk	B

Retail packages are packed in clamshell with 4 color label

Unintentional detachment to comply with ABYC.  
7" x 7" swivel rotates 360°.  
Use with fixed height posts (for fishing only).

Hi-Rise seat mount adds 2-11/16" to height of post.

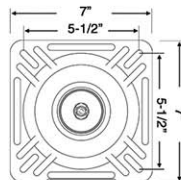

A

KingPin™ Seat Mounts Are  
Rated ABYC Class H-31 B



## FIXED HEIGHT POSTS

OEM IMAGE	PART NUMBER	DIAMETER	HEIGHT	FINISH	PACK QUANTITY	ABYC
A.	3793012-A	2-3/8"	12"	Anodized	20 Bulk	AP
A.	3793013-A	2-3/8"	13"	Anodized	20 Bulk	AP

Sturdy 2-3/8" high-strength aluminum posts. Available as anodized or polished. Locking collar prevents unintentional removal from base. Use with Trac-Lock™ non-locking seat mount, (sold separately).

(For use underway)



Underway Posts Are Rated ABYC Class H-31 AP



## HI-LO FIXED HEIGHTS POSTS

OEM IMAGE	PART NUMBER	DIAMETER	HEIGHT	FINISH	PACK QUANTITY	ABYC
A.	3793211	2-3/8"	11"	Anodized	20 Bulk	B

Sturdy 2-3/8" high-strength aluminum posts anodized finish. Bottom locking collar prevents unintentional removal from base.

Use with KingPin™ seat mount, (sold separately). Use with any Thread-Lock™ base (sold separately). (For Fishing Only)



Fishing Posts Are Rated ABYC Class H-31 B



## ALUMINUM BASES

OEM IMAGE	PART NUMBER	DIAMETER	FINISH	PACK QUANTITY
A.	3796010-AL	10" Base	Anodized	20 Bulk
B.	3796010-PL	10" Base	Polished	20 Bulk
C.	3796010-SL	10" Base	Satin	20 Bulk

High-strength aluminum bases, available as Anodized, Polished, or satin finish. No hole in deck required.

Use with any Thread-Lock™ fixed height post (sold separately). Can also be used with Thread-Lock™ Table and Grill posts (sold separately).



Anodized

Polished

Satin

Underway Posts Are Rated ABYC Class H-31 AP



Thread-Lock™ seating bases can also be used with Thread-Lock™ Grill and Table systems. DO NOT USE SEATING POSTS IN BASES MADE FOR GRILLS or TABLES.

## THREAD-LOCK™ ACCESSORIES

RETAIL IMAGE	PART NUMBER	DESCRIPTION	PACK QUANTITY
A.	2100092	Plastic Base socket cover	6 Retail

OEM IMAGE	PART NUMBER	DESCRIPTION	PACK QUANTITY
A.	2100092-B	Plastic Base socket cover	20 Bulk

Plastic base socket cover keeps socket clear when not in use. Fits any Thread-Lock™ base.

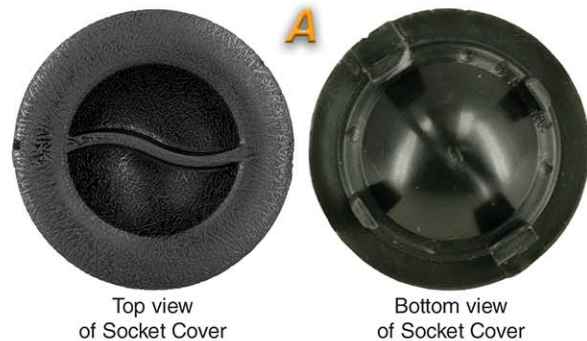

Top view of Socket Cover

Bottom view of Socket Cover

# Spring-Lock™ Series

## ABOUT SPRING-LOCK™

Springfield Marine presents Spring-Lock™ ... the world's first push button activated pedestal. The industry demanded it -- we created it. High strength stainless steel post for long lasting durability.

With Spring-Lock™ pedestals, we've combined a sturdy and secure ride with fast and easy post removal. The locking latch of the Spring-Lock™ extends from the post and secures it in the base. A push of the button and the latch unlocks the post from the base for easy removal.

For an even simpler approach, Springfield Marine presents the Clip-Lock even better performance and an easier-to-use system. Designed to capture the end of the post, the base provides all the strength needed to hold it in place during punishing freshwater action. Simply plug the Clip-Lock into the base and go. When you are done, a simple pull on the post removes it up and out of the base.

PACKAGES • SEAT MOUNTS • PEDESTALS • BASES • ACCESSORIES



Use On:



Fishing Boats



Spring-Lock™

(Locking)

PRODUCTS IN THE SPRING-LOCK™ / CLIP-LOCK SERIES ARE DESIGNED FOR RECREATIONAL USE ONLY



[www.springfieldgrp.com](http://www.springfieldgrp.com)



## CLIP-LOCK 3-PIECE PACKAGES

RETAIL IMAGE	PART NUMBER	DESCRIPTION	PACK QUANTITY	ABYC
A.	1644513-S	3-Piece Non-Locking Package	1 Retail	B

3-Piece set (A.) includes the following parts:

- 13" Clip-Lock non-locking satin post (#3640513-S)
- Spring-Lock™ Non-Locking Swivel (#3640202)
- 7" x 7" non-locking square base (#3640013-CL)

Retail packed in box with 4 color label



Clip-Lock Packages Are Rated ABYC Class H-31 B

## POWER-RISE ADJUSTABLE SIT DOWN POSTS

RETAIL IMAGE	PART NUMBER	MATERIAL	ADJUSTS	FINISH	PACK QUANTITY	ABYC
A.	1642005	Stainless Steel	15" to 21-1/2"	Polished	1 Retail	B

OEM IMAGE	PART NUMBER	MATERIAL	ADJUSTS	FINISH	PACK QUANTITY	ABYC
A.	3641007	Stainless Steel	15-1/2" to 21-1/2"	Polished	2 Bulk	B
A.	3641013	Stainless Steel	13-1/2" to 18"	Polished	2 Bulk	B
B.	3641507	Aluminum	16" to 22-1/2"	Anodized	2 Bulk	B
B.	3642507-BAS	Aluminum	16" to 22-1/2"	Brite Dip	2 Bulk	B

Retail packages are packed in clamshell with 4 color label

**Spring-Lock™ (A.) sit down posts**

Adjustable height from 13-1/2" to 20" (unless noted).  
3 degree tilt cast aluminum swivel, rotates 360°. Use with any non-locking Spring-Lock™ base, (sold separately).

**Clip-Lock (B.) sit down posts**

Adjustable height from 16" to 22-1/2"  
3 degree tilt cast aluminum swivel, rotates 360°. Use with any non-locking Spring-Lock™ base, (sold separately).

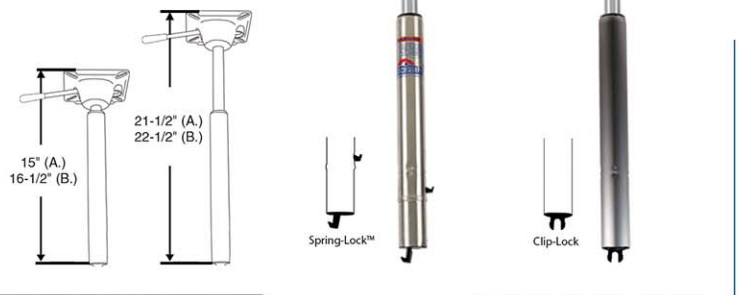

Power-Rise Posts Are Rated ABYC Class H-31 B

## POWER-RISE ADJUSTABLE STAND-UP POSTS

RETAIL IMAGE	PART NUMBER	MATERIAL	ADJUSTS	FINISH	PACK QUANTITY	ABYC
A.	1642008	Stainless Steel	22" to 28-1/2"	Polished	1 Retail	B

OEM IMAGE	PART NUMBER	MATERIAL	ADJUSTS	FINISH	PACK QUANTITY	ABYC
A.	1641009	Stainless Steel	22" to 28-1/2"	Polished	1 OEM	B
A.	1641019	Stainless Steel	25-1/2" to 32-1/2"	Polished	1 OEM	B
B.	3641508-AS	Aluminum	22-1/2" to 29"	Anodized	1 OEM	B

Retail packages are packed in clamshell with 4 color label

**Spring-Lock™ (A.) stand up posts**

Height adjusts from 22-1/2" to 29-1/2" (unless noted).  
3 degree tilt cast aluminum swivel, rotates 360°. Use with any non-locking Spring-Lock™ base.

**Clip-Lock™ (B.) stand up posts**

Height adjusts from 22-1/2" to 29-1/2" (unless noted).  
3 degree tilt cast aluminum swivel, rotates 360°. Use with any non-locking Spring-Lock™ base.



Power-Rise Posts Are Rated ABYC Class H-31 B

# Spring-Lock™ Series

## POWER-RISE STAND-UP PACKAGE

RETAIL IMAGE	PART NUMBER	DESCRIPTION	PACK QUANTITY	ABYC
A.	1641037	Power-Rise Stand-Up Package	1 Retail	B
B.	1643013	Power-Rise Stand-Up Post	1 Retail	B

Stand-Up Posts Are Rated ABYC Class H-31 B



3-Piece set (A.) includes the following parts:

- Power-Rise Stand-Up post (#1643013)
- Quik-Tilt seat mount (#1615254-EC)
- Gray pro stand up seat (#1040213)

(1643013) Stainless steel post.

Adjusts from 26-5/16" to 33-5/16". Use with any non-locking Spring-Lock™ base (sold separately).

Use as seat or leaning post (add 2-3/4" height for seat mount) (add 4-3/4" height for seat thickness) Quik-Tilt seat mount tilts in 4 snap-in angles (0°, 30°, 60°, 90°)

3/4" Hole in top works with any KingPin™ seat mount



## NON-LOCKING SEAT MOUNTS

RETAIL IMAGE	PART NUMBER	DESCRIPTION	FINISH	PACK QUANTITY	ABYC
A.	1640202	Spring-Lock™ Seat Mount	E-Coat	1 Retail	B
B.	1640203	Hi-Rise Seat Mount	Powder Coat	1 Retail	B

OEM IMAGE	PART NUMBER	DESCRIPTION	FINISH	PACK QUANTITY	ABYC
A.	3640202	Spring-Lock™ Seat Mount	E-Coat	20 Pack	B
B.	3640203	Hi-Rise Seat Mount	Powder Coat	20 Pack	B

Non-Locking Swivels Are Rated ABYC Class H-31 B

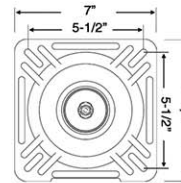

Retail packages are packed in clamshell with 4 color label

Use with any Spring-Lock™ or Clip-lock non-locking posts. E-coat or Powder Coated finish to resist corrosion.



## LOCKING SEAT MOUNTS

RETAIL IMAGE	PART NUMBER	DESCRIPTION	FINISH	PACK QUANTITY	ABYC
A.	1680203	Locking Spring-Lock™ Seat Mount	Powder Coat	1 Retail	AD

OEM IMAGE	PART NUMBER	DESCRIPTION	FINISH	PACK QUANTITY	ABYC
A.	3680203	Locking Spring-Lock™ Seat Mount	Powder Coat	20 Bulk	AD

Locking Swivels Are Rated ABYC Class H-31 AD



Retail packages are packed in clamshell with 4 color label

Use with any locking Spring-Lock™ post. Powder coat finish to resist corrosion. Swivel adds 1/4" to height of pedestal.



SPRING-LOCK™ SERIES



## SPRING-LOCK™ NON-LOCKING POSTS

RETAIL						
IMAGE	PART NUMBER	DESCRIPTION	HEIGHT	PACK QUANTITY	ABYC	
A.	1640401	Non-Locking Offset Post	13-1/2"	6 Retail	B	
B.	1640404	Non-Locking Post	11-1/4"	6 Retail	B	
B.	1640403	Non-Locking Post	15-1/2"	6 Retail	B	
B.	1640425	Non-Locking Post	18"	6 Retail	B	

OEM						
IMAGE	PART NUMBER	DESCRIPTION	HEIGHT	PACK QUANTITY	ABYC	
A.	3640401	Non-Locking Offset Post	11-1/2"	20 Bulk	B	
B.	3640411	Non-Locking Post	13-1/2"	20 Bulk	B	
B.	3640413	Non-Locking Post	13-1/2"	20 Bulk	B	
B.	3640415	Non-Locking Post	15-1/2"	20 Bulk	B	
B.	3640425	Non-Locking Post	25"	10 Bulk	B	

Retail packages are packed in clamshell with 4 color label

Hefty 1-3/4" diameter stainless steel posts.  
Use with non-locking Spring-Lock™ seat mounts (sold separately).  
Use with any non-locking Spring-Lock™ base (sold separately).



## SPRING-LOCK™ LOCKING POSTS

RETAIL						
IMAGE	PART NUMBER	DESCRIPTION	HEIGHT	PACK QUANTITY	ABYC	
A.	1680411	Locking Spring-Lock™ Post	11-1/4"	6 Retail	AD	
B.	1680415	Locking Spring-Lock™ Post	15-1/2"	6 Retail	AD	

OEM						
IMAGE	PART NUMBER	DESCRIPTION	HEIGHT	PACK QUANTITY	ABYC	
A.	3680411	Locking Spring-Lock™ Post	11-1/4"	20 Bulk	AD	
B.	3680415	Locking Spring-Lock™ Post	15-1/2"	20 Bulk	AD	

Retail packages are packed in clamshell with 4 color label

Hefty 1-3/4" diameter stainless steel posts.  
Use with any locking Spring-Lock™ seat mounts (sold separately).  
Use with any locking Spring-Lock™ base (sold separately).



## CLIP-LOCK™ NON-LOCKING POSTS

OEM						
IMAGE	PART NUMBER	DESCRIPTION	HEIGHT	FINISH	PACK QUANTITY	ABYC
A.	3640511-A	Non-Locking Post	11"	Anodized	20 Bulk	B
B.	3640513-A	Non-Locking Post	13-1/2"	Anodized	20 Bulk	B

Hefty 1-3/4" high-strength aluminum, available in a satin or anodized finish.

Use with Spring-Lock™ non-locking seat mounts (sold separately).  
Use with any Spring-Lock™ non-locking base (sold separately).

Additional sizes Available upon request.



SPRING-LOCK™ SERIES

# Spring-Lock™ Series

## 9" NON-LOCKING ROUND BASES

RETAIL	IMAGE	PART NUMBER	DESCRIPTION	SIZE	FINISH	PACK QUANTITY	ABYC
A.		1640002	Non-locking Base	9"	Satin	6 Retail	B

OEM	IMAGE	PART NUMBER	DESCRIPTION	SIZE	FINISH	PACK QUANTITY	ABYC
A.		3640002	Non-locking Base	9"	Satin	20 Bulk	B
B.		3640002-CLA	Non-locking Base	9"	Anodized	20 Bulk	B

Non-Locking Bases Are Rated ABYC Class H-31 B



Retail packages are packed in clamshell with 4 color label  
8" hole pattern, high-strength aluminum.  
Below the deck mount (requires a 4" hole in deck).  
Use with any Spring-Lock™ or Clip-Lock post,  
(sold separately).



## NON-LOCKING RECTANGULAR BASES

OEM	IMAGE	PART NUMBER	MATERIAL	SIZE	FINISH	PACK QUANTITY	ABYC
A.		3640022-PPCL	Stainless Steel	5" x 7"	Polished	20 Bulk	B
B.		3640024-CL	Stainless Steel	6" x 8"	Satin/E-Coat	20 Bulk	B
C.		3640025-CL	Stainless Steel	7" x 10"	Satin/E-Coat	20 Bulk	B
D.		3640028-CL	Stainless Steel	6" x 12"	Satin/E-Coat	20 Bulk	B

Non-Locking Bases Are Rated ABYC Class H-31 B



Bases are stainless steel.  
Below the deck mount (requires a 4" hole in deck).  
Use with any Spring-Lock™ or Clip-Lock post,  
(sold separately).

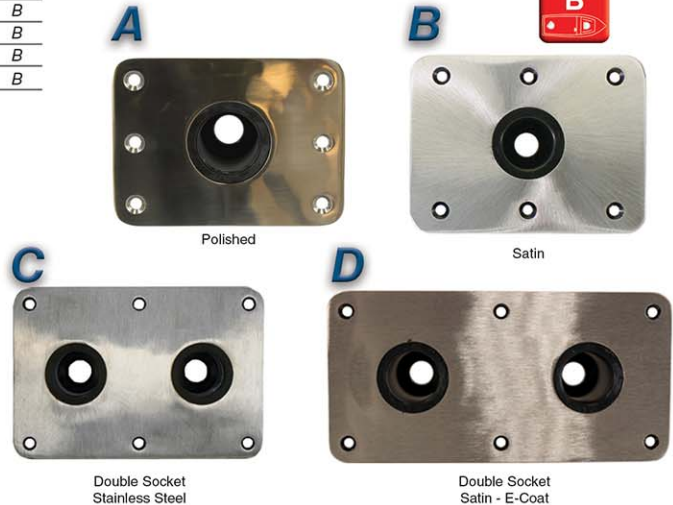
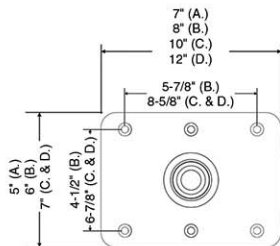

## 7" X 7" NON-LOCKING SQUARE BASES

RETAIL	IMAGE	PART NUMBER	DESCRIPTION	MATERIAL	FINISH	PACK QUANTITY	ABYC
A.		1640007-CL	7" x 7" Base	Mild Steel	Black Krinkle	6 Retail	B
C.		1640013-CL	7" x 7" Base	Stainless Steel	Satin	6 Retail	B

Non-Locking Bases Are Rated ABYC Class H-31 B



OEM	IMAGE	PART NUMBER	DESCRIPTION	MATERIAL	FINISH	PACK QUANTITY	ABYC
A.		3640007-CL	7" x 7" Base	Mild Steel	Black Krinkle	20 Bulk	AD
B.		3640012-PASSCL	7" x 7" Base	Stainless Steel	Polished	20 Bulk	AD
C.		3640013-CL	7" x 7" Base	Stainless Steel	Satin	20 Bulk	AD
D.		3640012-CL	7" x 7" under carpet	Stainless Steel	Mill	20 Bulk	AD
E.		3640021-CL	7" x 7" Offset Base	Mild Steel	Black Krinkle	20 Bulk	AD

Retail packages are packed in clamshell with 4 color label

Bases are stainless steel or mild steel.  
Available in a variety of finishes.  
Below the deck mount (requires a 4" hole in deck).  
Use with any Spring-Lock™ or Clip-Lock post.

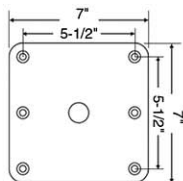

## 7" X 7" LOCKING SQUARE BASES

OEM IMAGE	PART NUMBER	DESCRIPTION	MATERIAL	FINISH	PACK QUANTITY	ABYC
A.	3680012-CL	7" x 7" under carpet	Stainless Steel	Mill	20 Bulk	AD
B.	3680012-PASSCL	7" x 7" Base	Stainless Steel	Polished	20 Bulk	AD
C.	3680013-CL	7" x 7" Base	Stainless Steel	Satin	20 Bulk	AD
D.	3680038-CL	4" x 8" Base	Stainless Steel	Satin	20 Bulk	AD

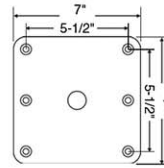

Locking Bases Are Rated  
ABYC Class H-31 AD



Bases are available as mild, or stainless steel construction.  
Below the deck mount requires a 4" hole in deck.  
Use with any locking Spring-Lock™ post, (sold separately).

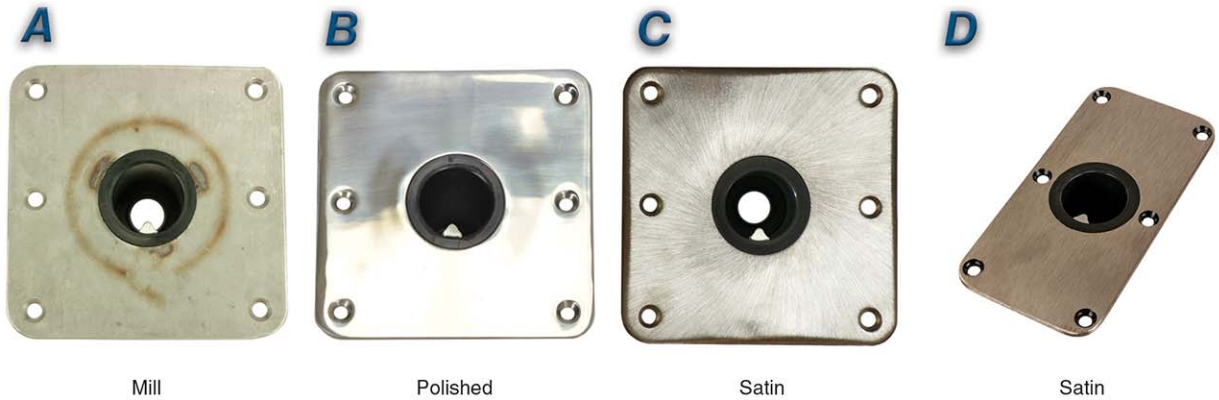

## SPRING-LOCK™ & CLIP-LOCK ACCESSORIES

RETAIL IMAGE	PART NUMBER	DESCRIPTION	PACK QUANTITY
A.	2100010	Replacement Seat Mount Bushing	6 Pack
B.	2100011	Replacement Locking Latch	6 Pack
C.	2100012	Replacement End Cap	6 Pack
D.	2100013	Replacement Post Bushing	6 Pack
E.	2100038	Spring-Lock base Repair Kit - 2 bushings	6 Pack
F.	2100040	Spring-Lock™ 2 Base Repair Kit	6 Pack
G.	2100091	Base Socket Cover	6 Pack

OEM IMAGE	PART NUMBER	DESCRIPTION	PACK QUANTITY
G.	2100091-B	Base Socket Cover	20 Bulk
H.	3640023	Splash Gaurd	20 Bulk

Base repair kits include: 1/2 oz bottle of glue with brush cap, plastic bushing, and wooden dowel mandrel.

Used on Spring-Lock base sockets under 2"

Used on current Spring-Lock™ 2 base sockets 2"



Replacement Parts For Spring-Lock™

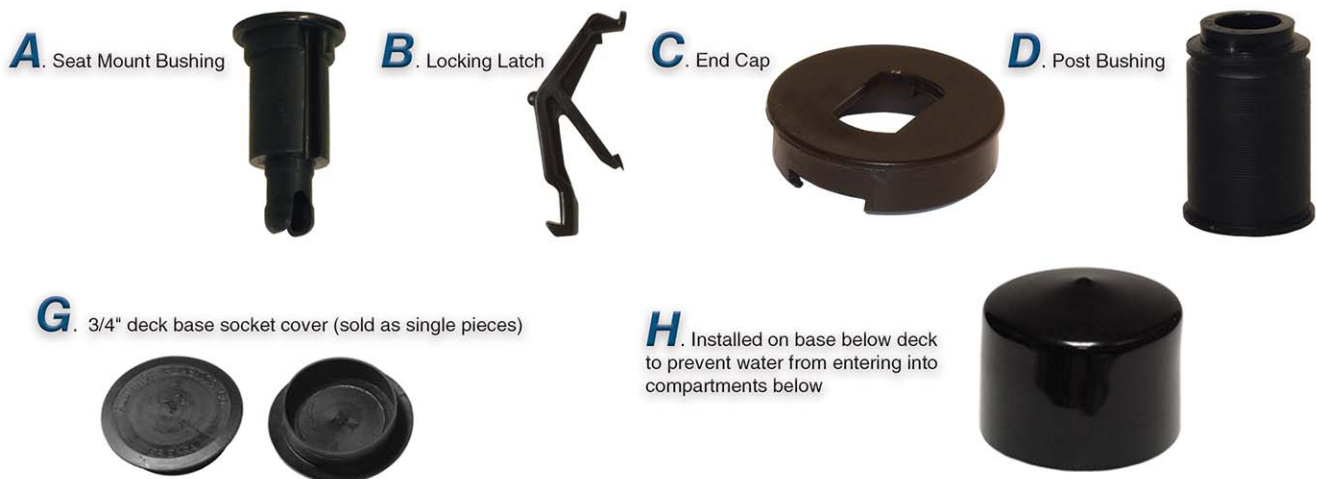

SPRING-LOCK™ SERIES

# 2-3/8" Series

## ABOUT 2-3/8" SERIES

Springfield Marine first generation non-removable pedestal system 2-3/8" series is still very popular for inland boats. The system uses a die-cast base with 2-3/8" aluminum extruded post for the pedestal and our famous Trac-Lock™ slides and swivels made with aluminum die-cast, powder coated swivel and extruded slide plates together provide a secure connection between the post and seat pedestal.

As a system this series exceeds the ABYC H-31 requirements for strength and durability. Tested in the lab and in the field with a proven record to last and satisfy.



PEDESTAL PACKAGES • SEAT MOUNTS • SLIDES AND SWIVELS • PEDESTALS



## REGULAR MAINSTAY PACKAGES

RETAIL					
IMAGE	PART NUMBER	ADJUSTS	SEAT MOUNT	PACK QUANTITY	ABYC
B.	1250100-L1	14" to 20"	3100031-LAR1	1 Pack	AD
C.	1250150-L1	14.5" to 20.5"	3100531-LAR1	1 Pack	AD

OEM					
IMAGE	PART NUMBER	ADJUSTS	SEAT MOUNT	PACK QUANTITY	ABYC
A.	1250100	14" to 20"	3100031-AR1	1 OEM	AP
B.	1250100-L	14" to 20"	3100031-LAR1	1 OEM	AD
C.	1250150-L	14.5" to 20.5"	3100531-LAR1	1 OEM	AD

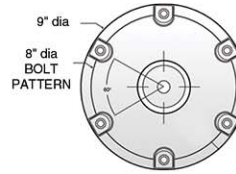

Mainstay Packages Are Rated ABYC Class H-31 AD & AP



Retail packed in box with 4 color label

- 2-3/8" pedestal with 9" round base, and anodized finish.
- Air-powered height adjustment from 14" to 20"
- Available with locking or non-locking Trac-Lock™ swivel or slide & swivel.



Non-Locking Swivel



Locking Swivel



Locking Slide & Swivel

## SHORT MAINSTAY PACKAGES

RETAIL					
IMAGE	PART NUMBER	ADJUSTS	SEAT MOUNT	PACK QUANTITY	ABYC
A.	1250200-L1	12.5" to 15.5"	3100031-LAR1	1 Retail	AD
B.	1250250-L1	12.5" to 15.5"	3100531-LAR1	1 Retail	AD

OEM					
IMAGE	PART NUMBER	ADJUSTS	SEAT MOUNT	PACK QUANTITY	ABYC
A.	1250200-L	12" to 15.5"	3100031-LAR1	1 OEM	AD
A.	1250206-L	10" to 12"	3100031-LAR1	1 OEM	AD
B.	1250250-L	12.5" to 16"	3100531-LAR1	1 OEM	AD
B.	1250256-L	10.5" to 12.5"	3100531-LAR1	1 OEM	AD
B.	1250256-LN	10" to 12"	3100531-LAR1	1 OEM	AD

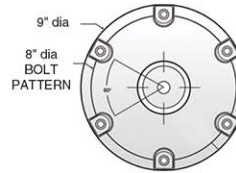

Short Mainstay Packages Are Rated ABYC Class H-31 AD



Retail packed in box with 4 color label

- 2-3/8" pedestal with 9" round base, and anodized finish.
- Air-powered height adjustment.
- Available with locking Trac-Lock™ swivel or slide & swivel.

(PN: 1250256-LN Has Extra Locking Slot Positioned at 45°)



Locking Swivel



Locking Slide & Swivel

# 2-3/8" Series

## THRU-DECK MAINSTAYS

RETAIL IMAGE	PART NUMBER	ADJUSTS	SEAT MOUNT	PACK QUANTITY	ABYC
A.	1250252-L	9" to 12"	3100531-LAR1	1 Retail	AD
A.	1250253-L	8-3/4" to 14-1/2"	3100531-LAR1	1 Retail	AD
B.	1250254-L	8-1/4" to 14"	3100031-LAR1	1 Retail	AD

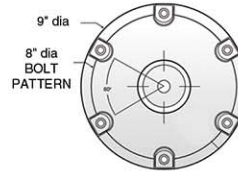

Thru-Deck Packages Are Rated ABYC Class H-31 AD



- 2-3/8" pedestal with 9" round base, anodized finish.
- Thru-Deck pedestals require a 3-3/4" hole in deck.
- Air-powered height adjustment.
- Available with locking Trac-Lock™ swivel or slide & swivel.

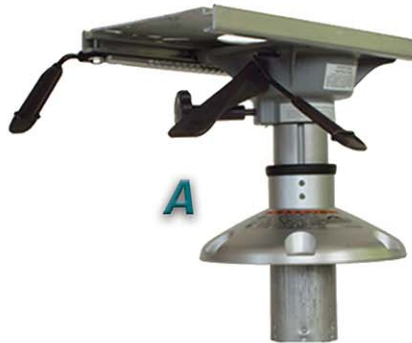

Slide & Swivel



Swivel Only

## MANUAL EXPLORER ADJUSTABLE PACKAGES

RETAIL IMAGE	PART NUMBER	ADJUSTS	SEAT MOUNT	PACK QUANTITY	ABYC
B.	1253032-L1	13-5/8" to 16-5/8"	3100031-L1	1 Retail	AD

Explorer Packages Are Rated ABYC Class H-31 AD



OEM IMAGE	PART NUMBER	ADJUSTS	SEAT MOUNT	PACK QUANTITY	ABYC
A.	1253031-L	13-7/8" to 16-7/8"	3100531-L1	1 Pack	AD
B.	1253032-L	13-5/8" to 16-5/8"	3100031-L1	1 Pack	AD
C.	1253031-MNS	12-1/2" to 15-1/2"	Not Included	5 Bulk	AD

Retail packed in box with 4 color label

- 2-3/8" adjustable pedestal with 9" round base
- Pedestal adjusts in 1 inch increments.
- Anodized post with satin base.
- Available with locking Trac-Lock™ swivel or slide & swivel.

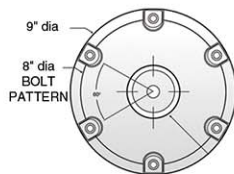

Slide & Swivel



Swivel



C

## EXPLORER FIXED HEIGHT PACKAGES

RETAIL IMAGE	PART NUMBER	FIXED HEIGHT	SEAT MOUNT	PACK QUANTITY	ABYC
A.	1250309	9"	3100031-1	1 Retail	AP
B.	1250309-L	9"	3100031-L1	1 Retail	AD
A.	1250312	12"	3100031-1	1 Retail	AP
B.	1250312-L	12"	3100031-L1	1 Retail	AD
B.	1250313-L	13"	3100031-L1	1 Retail	AD
A.	1250315	15"	3100031-1	1 Retail	AP
B.	1250315-L	15"	3100031-L1	1 Retail	AD

Retail packed in box with 4 color label

- 2-3/8" pedestal with 9" round base.
- Anodized fixed height post, with die cast satin base.
- Available with locking or non-locking Trac-Lock™ swivel or slide & swivel.

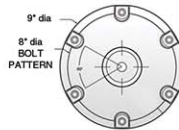

Mainstay Packages Are Rated ABYC Class H-31 AD & AP



## CLIPPER ADJUSTABLE PACKAGE

RETAIL IMAGE	PART NUMBER	ADJUSTS	SEAT MOUNT	PACK QUANTITY	ABYC
A.	1440334	13" to 18"	3100031-1	1 Retail	B

Retail packed in box with 4 color label



- 2-3/8" adjustable pedestal with 10" round base.
- Adjusts 13" to 18" in 1 inch increments.
- Anodized finish.
- Includes non-locking Trac-Lock™ swivel.
- Retail Box

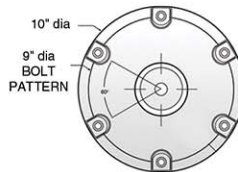

Clipper Packages Are Rated ABYC Class H-31 B



## CLIPPER FIXED HEIGHT PACKAGES

RETAIL IMAGE	PART NUMBER	ADJUSTS	SEAT MOUNT	PACK QUANTITY	ABYC
A.	1440213	9"	3100031-1	1 Retail	AP
B.	1440213-L	9"	3100031-L1	1 Retail	AD
A.	1440220	12"	3100031-1	1 Retail	AP
B.	1440220-L	12"	3100031-L1	1 Retail	AD
A.	1440228	15"	3100031-1	1 Retail	AP

Retail packed in box with 4 color label

- 2-3/8" pedestal with 10" round base.
- Brite Dip fixed height post, with satin base.
- Available with locking or non-locking Trac-Lock™ swivel.

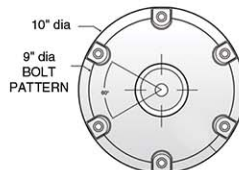

Clipper Packages Are Rated ABYC Class H-31 AD & AP



# 2-3/8" Series

## TRAC-LOCK™ SWIVELS

RETAIL				
IMAGE	PART NUMBER	DESCRIPTION	PACK QUANTITY	ABYC
A.	1100031-1	Non-locking Swivel	6 Retail	AP
B.	1100031-L1	Locking Swivel	6 Retail	AD

OEM				
IMAGE	PART NUMBER	DESCRIPTION	PACK QUANTITY	ABYC
A.	3100031-1	Non-locking Swivel	20 Bulk	AP
B.	3100031-L1	Locking Swivel	20 Bulk	AD
C.	3100031-LAR1	Locking Air-Ride Swivel	20 Bulk	AD

Retail packages are packed in clamshell with 4 color label

2-3/8" post mount with bushing for snug fit. Made of high-strength aluminum with powder coat finish. Available as Air-Ride, locking, or non-locking. Centrally located locking handle, easy to reach with left or right hand. Swivel rotates 360°, and adds 3/4" to height of pedestal.

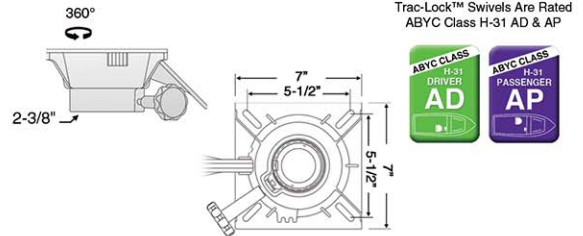

## TRAC-LOCK™ SLIDES & SWIVELS

RETAIL				
IMAGE	PART NUMBER	DESCRIPTION	PACK QUANTITY	ABYC
A.	1100531-1	Non-locking Slide & Swivel	6 Retail	AP
B.	1100531-L1	Locking Swivel	6 Retail	AD

OEM				
IMAGE	PART NUMBER	DESCRIPTION	PACK QUANTITY	ABYC
A.	3100531-1	Non-locking Slide & Swivel	10 Bulk	AP
B.	3100531-L1	Locking Swivel	10 Bulk	AD
C.	3100531-LAR1	Locking Air-Ride Slide & Swivel	10 Bulk	AD

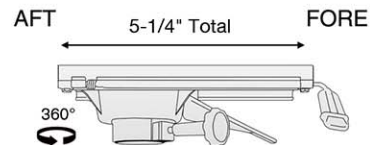

Trac-Lock™ Slides Are Rated ABYC Class H-31 AD & AP



Retail packages are packed in clamshell with 4 color label

High-strength aluminum slide & swivel, rotates 360°. Large 7-1/4" x 13" seat mounting platform, travels 5-1/4" forward and backward on self-lubricating pads. Centrally located locking handle, easy to reach with left or right hand. Adds 1-1/4" to height of pedestal.

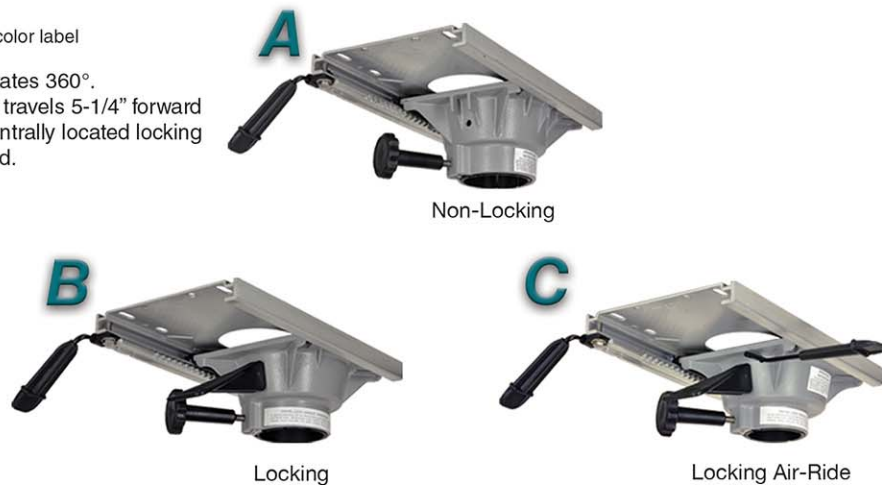
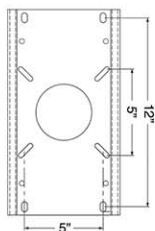



## EXPLORER FIXED HEIGHT PEDESTALS

RETAIL IMAGE	PART NUMBER	HEIGHT	LOCKING / NON-LOCKING	PACK QUANTITY	ABYC
A.	1250309-LNS	9"	Locking	1 Retail	AD
A.	1250310-LNS	10"	Locking	1 Retail	AD
A.	1250312-LNS	12"	Locking	1 Retail	AD
A.	1250313-LNS	13"	Locking	1 Retail	AD
A.	1250314-LNS	14"	Locking	1 Retail	AD

OEM IMAGE	PART NUMBER	HEIGHT	LOCKING / NON-LOCKING	PACK QUANTITY	ABYC
A.	1250307-MLNS	7"	Locking	5 Bulk	AD
A.	1250308-MLNS	8"	Locking	5 Bulk	AD
A.	1250309-MLNS	9"	Locking	5 Bulk	AD
A.	1250310-MLNS	10"	Locking	5 Bulk	AD
A.	1250312-MLNS	12"	Locking	5 Bulk	AD
A.	1250313-MLNS	13"	Locking	5 Bulk	AD
A.	1250315-MLNS	15"	Locking	5 Bulk	AD
A.	1250351-MLNS	11"	Locking	5 Bulk	AD
A.	1250354-MLNS	14"	Locking	5 Bulk	AD

Retail packed in box with 4 color label

2-3/8" pedestal with 9" round base.  
Anodized aluminum post, with die cast satin base.  
Use with Trac-Lock™ slide or swivel (sold separately).

Available in a variety of heights.

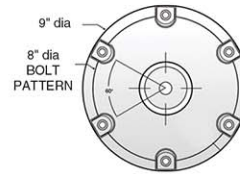

Explorer Pedestals Are Rated  
ABYC Class H-31 AD



Locking  
Satin

## CLIPPER FIXED HEIGHT PEDESTALS

RETAIL IMAGE	PART NUMBER	HEIGHT	POST FINISH	PACK QUANTITY	ABYC
A.	1440013-SAL	13"	Anodized Finish	1 Retail	AD

OEM IMAGE	PART NUMBER	HEIGHT	POST FINISH	PACK QUANTITY	ABYC
B.	1440010-DSL	10"	Polished/Satin Finish	2 Bulk	AD
A.	1440607-MAL	7"	Anodized Finish	5 Bulk	AD
A.	1440609-MAL	9"	Anodized Finish	5 Bulk	AD
A.	1440610-MAL	10"	Anodized Finish	5 Bulk	AD
A.	1440612-MAL	12"	Anodized Finish	5 Bulk	AD
A.	1440613-MAL	13"	Anodized Finish	5 Bulk	AD
A.	1440615-MAL	15"	Anodized Finish	5 Bulk	AD

Retail packed in box with 4 color label

2-3/8" pedestal with 10" round base and 9" mounting pattern.  
Use with locking Trac-Lock™ slide or swivel (sold separately).

Available in a variety of heights.

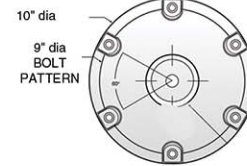

Clipper Pedestals Are Rated  
ABYC Class H-31 AD



Anodized Post  
& Base



Polished Post  
Satin Base

# 2-7/8" Series

## ABOUT 2-7/8" SERIES

Springfield Marine Second Generation non-removable pedestal system in 2-7/8" offers a heavy duty base and post for today's larger and faster recreational boats. The base is permanent mold AC7A aluminum alloy with anodized finish for maximum strength and corrosion protection. Then a 2-7/8" heavy duty extruded post is pressed and hydra-formed into the base mechanically forming them together. This proprietary process allows maximum strength for a sturdy pedestal.

TRAC-LOCK™ • PRESTIGE • CAMLOCK • EZ-RIDE • MAINSTAY • SECOND GENERATION • REGATTA



## HEAVY-DUTY MAINSTAY PACKAGES

OEM IMAGE	PART NUMBER	ADJUSTS	SEAT MOUNT	BASE SIZE	PACK QUANTITY	ABYC
A.	1250300	14" to 19.5"	3100021-LAR1	9"	1 OEM	AD
B.	1250301	14.5" to 20"	3100521-LAR1	9"	1 OEM	AD
B.	1250450-L	12" to 14.75"	3100521-LAR1	9"	1 OEM	AD
B.	1250456-L	10" to 12"	3100521-LAR1	9"	1 OEM	AD
C.	1250470-LC	12" to 15.5"	3101521-LARW	9"	1 OEM	AD
C.	1250471-LC	12" to 15.5"	3101521-LAR	9"	1 OEM	AD
D.	1250456-LC	10" to 12"	3101521-LAR	9"	1 OEM	AD

- 2-7/8" pedestal with 9" or 12" round base.
- Rigid 4 keyed aluminum post, anodized finish.
- Air-powered height adjustment.

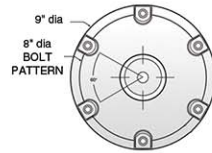

Swivel Only



Slide & Swivel



Extra Wide Prestige Seat Mount & Locking Collar



Slide and Swivel & Locking Collar

Mainstay Packages Are Rated ABYC Class H-31 AD



## 12" HEAVY DUTY MAINSTAY PEDESTALS

OEM IMAGE	PART NUMBER	ADJUSTS	BASE SIZE	SEAT MOUNT	PACK QUANTITY	ABYC
A.	1250321	14.5" to 20"	12"	3100521-LAR	1 OEM	AD
B.	1250321-NS	13.25" to 18.75"	12"	No Swivel	1 OEM	AD
B.	1250326-NS	16.5" to 23"	12"	No Swivel	1 OEM	AD
B.	1250328-NS	24" to 30.5"	12"	No Swivel	1 OEM	AD
C.	1250356-LC2	10" to 12"	12"	3100521-LAR	1 OEM	AD
D.	1252140	25-1/4" to 32-3/4"	12"	3101521-LARW	1 OEM	AD

- 2-7/8" pedestal with 12" round base, anodized finish.
- Rigid 4 keyed aluminum post. Air-powered height adjustment.

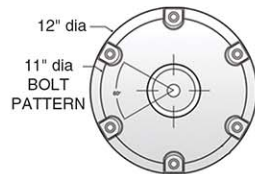

Heavy Duty Mainstay



No Seat Mount



Heavy Duty Mainstay w/ Tension knob



Heavy Duty Pedestal Package

Mainstay Pedestals Are Rated ABYC Class H-31 AD



## SECOND GENERATION MANUAL ADJUSTABLE PEDESTALS

RETAIL IMAGE	PART NUMBER	ADJUSTS	FINISH	PACK QUANTITY	ABYC
B.	1240749-LNS	14-3/8" to 20-3/8"	Anodized	1 Pack	AD

OEM IMAGE	PART NUMBER	ADJUSTS	FINISH	PACK QUANTITY	ABYC
A.	1240748-MLNS	11-7/8" to 14-3/4"	Anodized	5 Bulk	AD
B.	1240749-MLNS	14-3/8" to 20-3/8"	Anodized	5 Bulk	AD
C.	1240750-MLNS	17-1/4" to 23-1/4"	Anodized	5 Bulk	AD
D.	1240752-MLNS	20" to 26"	Anodized	5 Bulk	AD

Retail packages are packed in box with 4 color label

- 2-3/8" inner post with 2-7/8" locking adapter, 9" round base. Adjusts in 1 inch increments. Anodized post and base. Use with 2-7/8" Trac-Lock™ slide or swivel (sold separately).

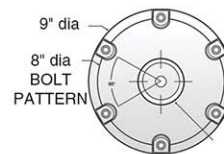

Adjustable Pedestals Are Rated ABYC Class H-31 AD



# 2-7/8" Series

## THRU-DECK ELECTRIC PEDESTALS

OEM IMAGE	PART NUMBER	ADJUSTS	FINISH	PACK QUANTITY	ABYC
A.	1271338-PEF1	2" to 5"	Aluminum	1 OEM	AD
B.	1271380-01	7-1/4" to 11-1/4"	Aluminum	1 OEM	AD

Mainstay Packages Are Rated ABYC Class H-31 AD



Heavy Duty Actuator, Electric Pedestal Thru-Deck Adjusts from 2" to 5" 12 Volt Power, with anodized aluminum plate. 6.65" Below deck 4" Post.

9" x 12.5" Mounting Pattern

Electric pedestals require 12 volt DC / 14 amp power.

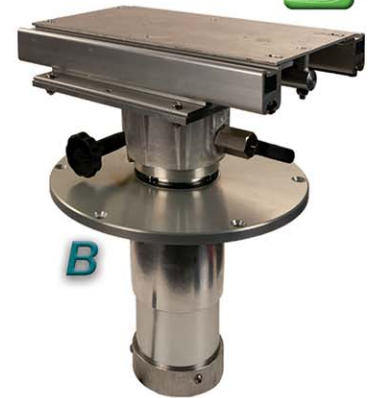

## ELECTRIC MAINSTAY

OEM IMAGE	PART NUMBER	ADJUSTS	BASE SIZE	PACK QUANTITY	ABYC
A.	1251415-02	12-1/8" to 14-1/8"	9"	1 OEM	AD
A.	1251415-04	14-1/8" to 18-1/8"	9"	1 OEM	AD
A.	1251315-06	16-1/8" to 22-1/8"	12"	1 OEM	AD

Mainstay Pedestals Are Rated ABYC Class H-31 AD



12 Volt In-Line Actuator

Electric pedestals require 12 volt DC / 14 amp power.

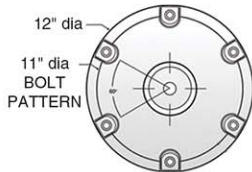

## ELECTRIC TRAC-LOCK

RETAIL IMAGE	PART NUMBER	DESCRIPTION	PACK QUANTITY	ABYC
A.	3100521-EL1	Trac-Lock Electric Slide & Swivel	1 Pack	AD
B.	3101521-LE	Prestige Electric Slide & Swivel	1 Pack	AD

Adjustable Pedestals Are Rated ABYC Class H-31 AD



Retail packages are packed in clamshell with 4 color label

High-strength aluminum slide & swivel, rotates 360°. Large 7-1/4" x 13" seat mounting platform, travels 5-1/4" forward and backward on self-lubricating pads. Centrally located locking handle, easy to reach with left or right hand. Adds 1-1/4" to height of pedestal.

Electric pedestals require 12 volt DC / 14 amp power.

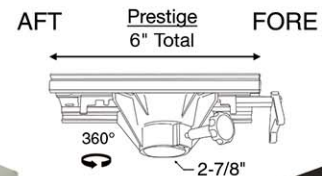
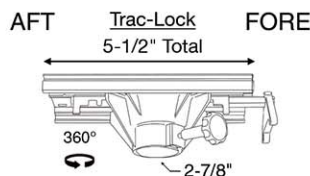
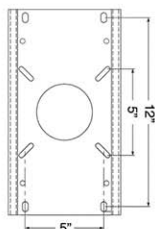

## SECOND GENERATION PACKAGES

Second Generation Packages Are Rated ABYC Class H-31 AD & AP



RETAIL IMAGE	PART NUMBER	HEIGHT	SEAT MOUNT	PACK QUANTITY	ABYC
B.	1240609-L1	9"	3100021-L1	1 Retail	AD
B.	1240612-L1	12"	3100021-L1	1 Retail	AD
A.	1240616	12"	3100021-1	1 OEM	AP
C.	1240716-L	12"	3100521-L1	1 OEM	AD
B.	1240615-L1	15"	3100021-L1	1 Retail	AD
A.	1240629	18"	3100021-1	1 OEM	AP
B.	1240629-L	18"	3100021-L1	1 OEM	AD
C.	1240729-L	18"	31000521-L1	1 OEM	AD
A.	1240639	24"	3100021-1	1 OEM	AP
C.	1240739-L	24"	3100521-L1	1 OEM	AD

Retail packed in box with 4 color label

- 2-7/8" pedestal with 9" round anodized base.
- 2-7/8" High-strength anodized aluminum post.
- Available in a variety of heights.
- Available with locking or non-locking Trac-Lock™ swivel or slide & swivel.

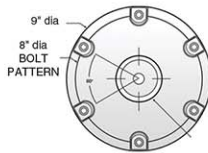

## 2-7/8" EXPLORER PACKAGES

Explorer Packages Are Rated ABYC Class H-31 AD & AP



RETAIL IMAGE	PART NUMBER	HEIGHT	SEAT MOUNT	PACK QUANTITY	ABYC
A.	1250533	10"	3100021-1	1 Retail	AP
A.	1250535	12"	3100021-1	1 Retail	AP
B.	1250535-L	12"	3100021-L1	1 Retail	AD
A.	1250540	18"	3100021-1	1 Retail	AP
B.	1250540-L	18"	3100021-L1	1 Retail	AD
B.	1250545-L	24"	3100021-L1	1 Retail	AD
A.	1250550	30"	3100021-1	1 Retail	AP
B.	1250550-L	30"	3100021-L1	1 Retail	AD

Retail single packed in box.

- 2-7/8" Pedestal with 9" round base.
- 2-7/8" high-strength anodized aluminum post.
- Available in a variety of heights.
- Available with locking or non-locking Trac-Lock™ swivel.
- 9" Satin Aluminum Base.

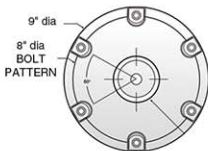

## CAMLOCK PEDESTAL PACKAGES

Camlock Packages Are Rated ABYC Class H-31 AD



RETAIL IMAGE	PART NUMBER	HEIGHT	SEAT MOUNT	PACK QUANTITY	ABYC
A.	1260012	12"	3100930-A1	1 Retail	AD
B.	1260018	18"	3100930-A1	1 Retail	AD
C.	1260024	24"	3100930-A1	1 Retail	AD

Retail single packed in box.

- 2-7/8" Camlock slide & swivel with pedestal.
- Large 7-1/4" x 13" mounting platform.
- High-strength anodized aluminum post.
- Seat mount rotates 360° and travels 6" forward and backward.
- One handle operates slide as well as swivel.
- 9" Satin Aluminum Base.

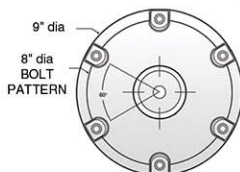

# 2-7/8" Series

## TRAC-LOCK™ SWIVELS

RETAIL IMAGE	PART NUMBER	DESCRIPTION	PACK QUANTITY	ABYC
A.	1100021-1	Non-locking Swivel	6 Retail	AP
B.	1100021-L1	Locking Swivel	6 Retail	AD

OEM IMAGE	PART NUMBER	DESCRIPTION	PACK QUANTITY	ABYC
A.	3100021-1	Non-locking Swivel	20 Bulk	AP
B.	3100021-L1	Locking Swivel	20 Bulk	AD
C.	3100021-CR1	Non-locking Chrome Swivel	1 OEM	AP
D.	3100021-LAR1	Locking Air-Ride Swivel	20 Bulk	AD

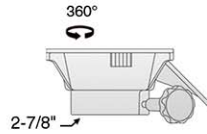

Trac-Lock™ Swivels Are Rated  
ABYC Class H-31 AD & AP



Retail packages are packed in clamshell with 4 color label

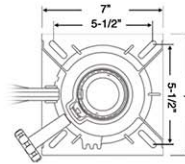

2-7/8" post mount with bushing & Tension knob for snug fit. Made of high-strength aluminum with powder coat finish. Rotates 360°. Available as air-ride locking, or non-locking. Centrally located locking handle, easy to reach with left or right hand.



## TRAC-LOCK™ SLIDES

RETAIL IMAGE	PART NUMBER	DESCRIPTION	PACK QUANTITY	ABYC
A.	1100521-1	Non-locking Slide & Swivel	6 Retail	AP
B.	1100521-L1	Locking Slide & Swivel	6 Retail	AD

OEM IMAGE	PART NUMBER	DESCRIPTIONS	PACK QUANTITY	ABYC
A.	3100521-1	Non-locking Slide & Swivel	10 Bulk	AP
B.	3100521-L1	Locking Slide & Swivel	10 Bulk	AD
C.	3100521-LAR1	Locking Air-ride Slide & Swivel	10 Bulk	AD
D.	3100521-LE1	Locking Extended Slide Handle	10 Bulk	AD
E.	3100521-LL1	Left Locking Swivel Handle	10 Bulk	AD
F.	3100521-LLL1	Left Locking Controls	10 Bulk	AD
G.	3100521-CL1	Cable activated Slide & Swivel	10 Bulk	AD
B.	3100521-LS1	Short Handle Slide	10 Bulk	AD

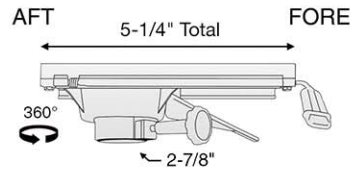

Trac-Lock™ Slides Are Rated  
ABYC Class H-31 AD & AP

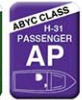

Retail packages are packed in clamshell with 4 color label

High-strength aluminum. Large 7-1/4" x 13" seat mounting platform, travels 5-1/4" forward and backward on self-lubricating pads. Centrally located locking handle, easy to reach with left or right hand. Rotates 360°. Available as air-ride, locking, or non-locking slides and swivels. Adds 1-1/4" to height of pedestal.

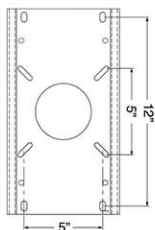

## 2-7/8" CAMLOCK SLIDE & SWIVEL

Camlock Slides Are Rated  
ABYC Class H-31 AD

RETAIL	IMAGE	PART NUMBER	DESCRIPTION	PACK QUANTITY	ABYC
	A.	1100930-A1	Slide & Swivel with telescoping handle	1 Retail	AD
	B.	3100931	5" Short Cam-Lock	1 Retail	AD

OEM	IMAGE	PART NUMBER	DESCRIPTION	PACK QUANTITY	ABYC
	A.	3100930-A1	Slide & Swivel with telescoping handle	10 Bulk	AD

High-strength aluminum, (large 7-1/4" x 13" platform) for **A** and a (Platform of 7-1/4" x 9-1/2") for **B** with (5" x 5" & 5" x 12" mounting pattern) for **A** and a (Mounting Pattern of 5" x 9-1/2") for **B**. Travels 6" forward and backward on self-lubricating pads. Automatically locks in forward position. Dual function activator handle operates slide as well as swivel, rotates 360°. Handle telescopes up to 3". Adds 1-1/2" to height of pedestal.

Patent #5,704,729

- 3100931 is used for Bolster Seats
- Platform: 7-1/4" x 9-1/2"
- Mounting Pattern: 5" x 9-1/2"

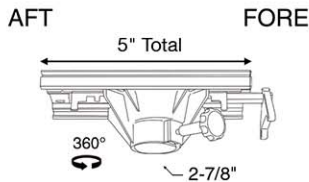
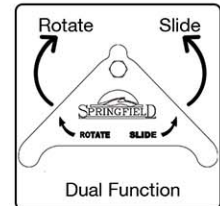
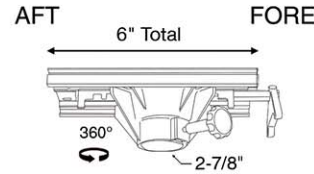

## PRESTIGE SLIDES

OEM	IMAGE	PART NUMBER	DESCRIPTIONS	PACK QUANTITY	ABYC
	A.	3101521-L	Locking Slide & Swivel	10 Bulk	AD
	B.	3101521-LAR	Air-ride Slide & Swivel	10 Bulk	AD
	C.	3101521-LW	Slide & Swivel, Extra wide plate	10 Bulk	AD
	D.	3101521-LARW	Air-ride Slide & Swivel, Extra wide plate	10 Bulk	AD
	E.	5191131	Replacement Lock Handle	10 Bulk	AD

Prestige Slides Are Rated  
ABYC Class H-31 AD

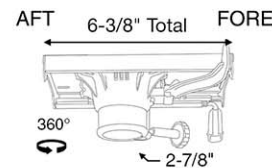

2-7/8" locking Prestige slides & swivels. Large 8" x 13" seat mount platform (extra wide: 14" x 13") travels 6-3/8" forward and backwards. Easy to reach handles. Adds 1-1/4" to height of pedestal.

- Aluminum Cast Swivel with deep throat and extended bushing for our most secure seat mount
- Extra large handles for ergonomic fit under the seat
- Plastic end caps for aesthetic design under seat
- Smooth anodized Slide Plate for function and design

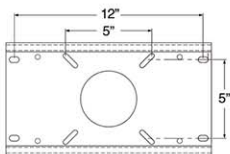

# 2-7/8" Series

## SECOND GENERATION FIXED HEIGHT PEDESTALS

Second Gen Pedestals Are Rated ABYC Class H-31 AD



OEM IMAGE	PART NUMBER	HEIGHT	POST	BASE	PACK QUANTITY	ABYC
A.	1240006-DAL	6"	Anodized	Anodized	2 Pack	AD
A.	1240009-DAL	9"	Anodized	Anodized	2 Pack	AD
A.	1240012-DAL	12"	Anodized	Anodized	2 Pack	AD
A.	1240014-DAL	14"	Anodized	Anodized	2 Pack	AD
A.	1240018-DAL	18"	Anodized	Anodized	2 Pack	AD
A.	1240020-DAL	20"	Anodized	Anodized	2 Pack	AD
A.	1240024-DAL	24"	Anodized	Anodized	2 Pack	AD

OEM IMAGE	PART NUMBER	HEIGHT	POST	BASE	PACK QUANTITY	ABYC
A.	1240006-MAL	6"	Anodized	Anodized	5 Pack	AD
A.	1240007-MAL	7"	Anodized	Anodized	5 Pack	AD
A.	1240008-MAL	8"	Anodized	Anodized	5 Pack	AD
A.	1240009-MAL	9"	Anodized	Anodized	5 Pack	AD
A.	1240010-MAL	10"	Anodized	Anodized	5 Pack	AD
A.	1240011-MAL	11"	Anodized	Anodized	5 Pack	AD
A.	1240012-MAL	12"	Anodized	Anodized	5 Pack	AD

Additional sizes and non-locking pedestals available upon request.

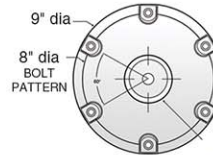

Anodized Base

## SECOND GENERATION FIXED HEIGHT PEDESTALS

Second Gen Pedestals Are Rated ABYC Class H-31 AD



OEM IMAGE	PART NUMBER	HEIGHT	POST	BASE	PACK QUANTITY	ABYC
A.	1240008-MSL	8"	Anodized	Satin	5 Pack	AD
B.	1240008-SAL	8"	Anodized	Anodized	1 Pack	AD
A.	1240010-MSL	10"	Anodized	Satin	5 Pack	AD
B.	1240012-SAL	12"	Anodized	Anodized	1 Pack	AD
B.	1240015-SAL	15"	Anodized	Anodized	1 Pack	AD

2-7/8" satin pedestals with 9" round satin floor base. Use with locking Trac-Lock™ slide or swivel (sold separately).

Permanent mold base is made from high magnesium content aluminum for corrosion resistance.

Additional sizes and non-locking pedestals available upon request.

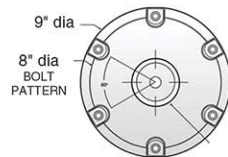

Satin Base



Anodized Base

## SECOND GENERATION FIXED HEIGHT PEDESTALS

Second Gen Pedestals Are Rated ABYC Class H-31 AD



OEM IMAGE	PART NUMBER	HEIGHT	POST	BASE	PACK QUANTITY	ABYC
A.	1240006-MPL	6"	Anodized	Polished	5 Pack	AD
A.	1240014-MPL	14"	Anodized	Polished	5 Pack	AD
A.	1240206-MPL	6"	Brite Dip	Polished	5 Pack	AD

Permanent mold base is made from high magnesium content aluminum for corrosion resistance.

Additional sizes and non-locking pedestals available upon request.

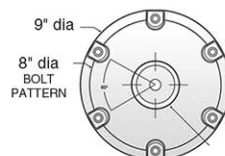

Polished Base



## EZ RIDE WAVE DAMPENING

EZ-Ride Pedestals Are Rated ABYC Class H-31 AD

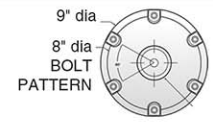

RETAIL IMAGE	PART NUMBER	DESCRIPTION	PACK QUANTITY	ABYC
A.	1080136-L1	2-7/8" EZ-Ride Pedestal Package	1 Pack	AD

OEM IMAGE	PART NUMBER	DESCRIPTION	PACK QUANTITY	ABYC
B.	1080136	2-7/8" EZ-Ride Wave Dampening Pedestal	1 Pack	AD

Uses a gas shock inside a mechanical spring to provide non adjustable wave dampening and soft ride.

12" anodized aluminum pedestal with 9" round base, 3-1/2" outer post with 2-7/8" inner post and four grooves with keys to provide rotation lock and restrict movement collar covers bushing and inner post keys.

- Allows 3-1/2" of vertical travel
- Developed and intended for recreational inshore use
- Tested to ABYC H31 dynamic static loads
- Additional height available upon request



## REGATTA PEDESTALS

Regatta Pedestals Are Rated ABYC Class H-31 AD



IMAGE	A.	B.	RETAIL
HEIGHT	ANODIZED	POLISHED	PACK QTY ABYC
4.5"	1280104-SAL1	-	1 Pack AD

IMAGE	A.	B.	C.	OEM
HEIGHT	ANODIZED	POLISHED	FLAT SIDE	PACK QTY ABYC
4.5"	1280104-MAL	1280104-MPL	-	5 OEM AD
4.5"	-	-	1281104-MAL	5 OEM AD
4.5"	-	-	1282104-MPL	5 OEM AD
6"	1280106-MAL	1280106-MPL	-	5 OEM AD
6"	1280106-MALW	-	-	5 OEM AD
7"	1280107-MAL	-	-	5 OEM AD
8"	1280108-MAL	1280108-MPL	-	5 OEM AD
9"	1280109-MAL	-	-	5 OEM AD
10"	1280110-MAL	-	-	5 OEM AD
11"	1280111-MALW	-	-	5 OEM AD

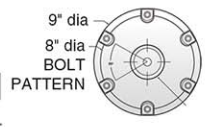

2-7/8" locking pedestal with 9" low-profile base combination. For use with any 2-7/8" locking Trac-Lock or Cam-Lock (sold separately).

Permanent mold base is made from high magnesium content aluminum for corrosion resistance.

MALW: Post is welded to base for maximum strength.

## STAINLESS STEEL FIXED HEIGHT

RETAIL IMAGE	PART NUMBER	FIXED	BASE SIZE	PACK QUANTITY	ABYC
A.	1280618-SS	18"	9"	2 Pack	AD
B.	1280624-SS	24"	9"	2 Pack	AD

Polished cast 9" round stainless steel base, welded to post for maximum strength. 2-7/8" post with heavy-duty thick wall construction. 316 grade stainless steel with #8 mirror finish.

Available in a variety of heights upon request. Use with any 2-7/8" Trac-Lock™ locking slide or swivel (sold separately)



2-7/8" SERIES

# 2-7/8" Series

## SCHOONER PEDESTALS WITH FLAT-SIDE

IMAGE	A.	B.		
HEIGHT	ANODIZED	SATIN	PACK QUANTITY	ABYC
6"	1260606-DAL	1260606-DSL	2 Bulk	AD
7"	1260607-MAL	-	5 Bulk	AD
10"	1260610-DAL	1260610-DSL	2 Bulk	AD
15"	1260615-DAL	-	2 Bulk	AD

2-7/8" locking pedestal with 9" flat-side base combination.  
Available with satin or anodized base.  
Use with 2-7/8" locking Trac-Lock™ slide or swivel (sold separately).

Molded with one flat side for compartment access.



Anodized Base



Satin Base

Schooner Pedestals Are Rated ABYC Class H-31 AD

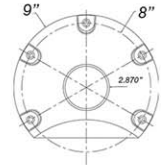

## LIMITED ROTATION

OEM IMAGE	PART NUMBER	DESCRIPTIONS	PACK QUANTITY	ABYC
A.	1280109-MALNW	Regatta, 2-7/8" HD w/ 9" Base	10 Bulk	AD
B.	3100930-A1N	Camlock Slide, 2-7/8"	10 Bulk	AD

OEM IMAGE	PART NUMBER	DESCRIPTIONS	PACK QUANTITY	ABYC
C.	1240008-MAL2	Second Generation, Anodized, 8"	10 Bulk	AD
C.	1240010-MAL2	Second Generation, Anodized, 10"	10 Bulk	AD
D.	1240008-MALN	Second Generation, Anodized, 8" w/ Stop Bolt	10 Bulk	AD
E.	3100521-LL1N	Trac-Lock III Slide, 2-7/8"	10 Bulk	AD

Schooner Pedestals Are Rated ABYC Class H-31 AD

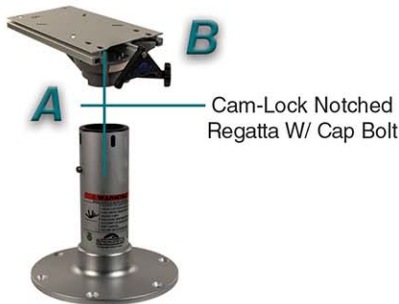

Cam-Lock Notched Regatta W/ Cap Bolt

Trac-Lock Slide/Swivel  
Second Generation Locking Slot 45°



45° locking slot

1240010-MAL2

1240008-MALN



2-7/8" SERIES

## HEAVY DUTY SECOND GENERATION PEDESTAL

OEM IMAGE	PART NUMBER	FIXED HEIGHT	BASE SIZE	FINISH	PACK QUANTITY	ABYC
A.	1250710-1DAL	10-1/8"	12"	Anodized	10 Bulk	AD

- Use with any 2-7/8" Seat Mount.
- 12" Anodized Base
  - 3.5 Anodized Post
  - 2-7/8" Seat Mount Adapter Post

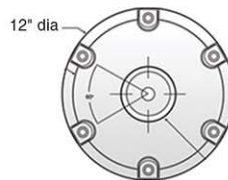

Other Heights Available upon Request.



## ABOUT 4" SERIES

Springfield Marine introduces the 4" Series For the most demanding work or pleasure boat applications, Springfield Marine's heavy-duty 4" Series is designed for rugged service and wobble free control.

4" Seat Mounts include: The Mariner & Mariner II, Workhorse, and Elite Series. The seating hardware of choice for the most extreme conditions.

4" Pedestals include: The Mainstay and Elite series. Available as Fixed height, or Adjustable Pedestals, in a variety of lengths and finishes. Corrosion resistant stainless steel or high-strength aluminum.



MARINER • MARINER II • WORKHORSE • ELITE • MAINSTAY



4" SERIES

# 4" Series

## ELECTRIC MAINSTAY 4"

### RETAIL

IMAGE	PART NUMBER	DESCRIPTION	ADJUSTS	PACK QUANTITY	ABYC
A.	1271340-PE	Aluminum Pedestal Package	17-1/4" to 22"	1 Retail	AD
A.	1271349-PE	Aluminum Pedestal Package	24-1/4" to 32"	1 Retail	AD
B.	1271640-SSE	Stainless Steel Pedestal Package	17-1/4" to 22"	1 Retail	AD
B.	1271649-SSE	Stainless Steel Pedestal Package	24-1/4" to 32"	1 Retail	AD
C.	1271333-PE	Thru-Deck Pedestal Package	14" to 18"	1 Retail	AD
C.	1271334-PE	Thru-Deck Pedestal Package	18" to 26"	1 Retail	AD

Package Includes:

- Electric Pedestal
- Mariner II 3100565-LAE Slide & Swivel
- Switches & Switch Box

4" diameter outer post, 3-1/2" inner post with 4" collar. 12" base with 11" hole pattern. Electric powered height adjustment. Lifts 500 lbs. Thick wall construction for maximum durability.

(A. & C.) Made from high-strength aluminum.

(B.) Made from 316 #8 mirror finish stainless steel.

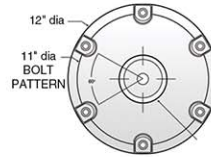

Electric Pedestals Are Rated ABYC Class H-31 AD



Electric pedestals require 12 volt DC / 14 amp power.

## MARINER II SLIDES & SWIVELS

### OEM

IMAGE	PART NUMBER	DESCRIPTION	FINISH	PACK QUANTITY	ABYC
A.	3100565-L	Locking Slide & Swivel	Black	1 Pack	AD
C.	3100565-LA	Locking Slide & Swivel	Anodized	1 Pack	AD
A.	3100565-LAR	Air-Ride Slide & Swivel	Black	1 Pack	AD
C.	3100565-LARA	Air-Ride Slide & Swivel	Anodized	1 Pack	AD
B.	3100565-LARW	Air-Ride Slide & Swivel	White	1 Pack	AD
B.	3100565-LW	Locking Slide & Swivel	White	1 Pack	AD

10-1/2" x 14-1/2" x 1/4" aluminum formed slide plate. Swivel clamps and locks onto a 4" post with stainless steel pin and rotates internally on 1/2" HDPE bearing for smooth operation in any position. Travels 6" fore and aft.

Mariner II slides & swivels are available as air-ride. Adds 3-7/8" to height of pedestal.

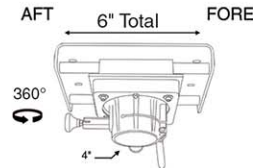

Mariner Slides & Swivels Are Rated ABYC Class H-31 AD



4" SERIES

## MARINER II SWIVELS

### OEM

IMAGE	PART NUMBER	DESCRIPTION	FINISH	PACK QUANTITY	ABYC
A.	3100065-L	Mariner II Locking Swivel	Anodized	1 Pack	AD
B.	3100065-L2	Mariner II Locking Swivel Offset	Anodized	1 Pack	AD

Large high strength aluminum mounting plate. Swivel clamps and locks onto a 4" post with stainless steel pin and rotates internally on 1/2" HDPE bearing for smooth operation in any position.

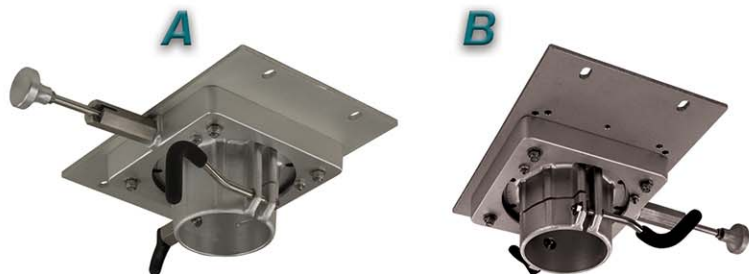

Swivel Only - Centered

Swivel Only - Offset

Mariner Slides & Swivels Are Rated ABYC Class H-31 AD



## WORKHORSE SLIDE & SWIVELS

OEM IMAGE	PART NUMBER	DESCRIPTION	FINISH	PACK QUANTITY	ABYC
A.	3100075-LB	Swivel Only	Black	1 Pack	AD
B.	3100075-L	Swivel Only	Anodized	1 Pack	AD
C.	3100075-LAR	Air-Ride Swivel Only	Anodized	1 Pack	AD
D.	3100575-LAR	Air-Ride Slide & Swivel	Anodized	1 Pack	AD
E.	3100575-LARW	Air-Ride Slide & Swivel	White	1 Pack	AD
F.	3100575-L	Slide & Swivel	Anodized	1 Pack	AD

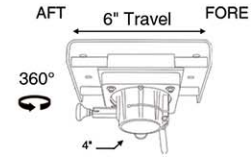

Workhorse Slides Are Rated  
ABYC Class H-31 AD



10-1/2" x 14-1/2" x 1/4" aluminum formed slide plate.  
Swivel locks and clamps tight to 4" post for rock  
solid performance. Heavy-duty stainless steel lock  
pin. Large easy to reach control knobs.  
Slide travels 6" fore and aft.

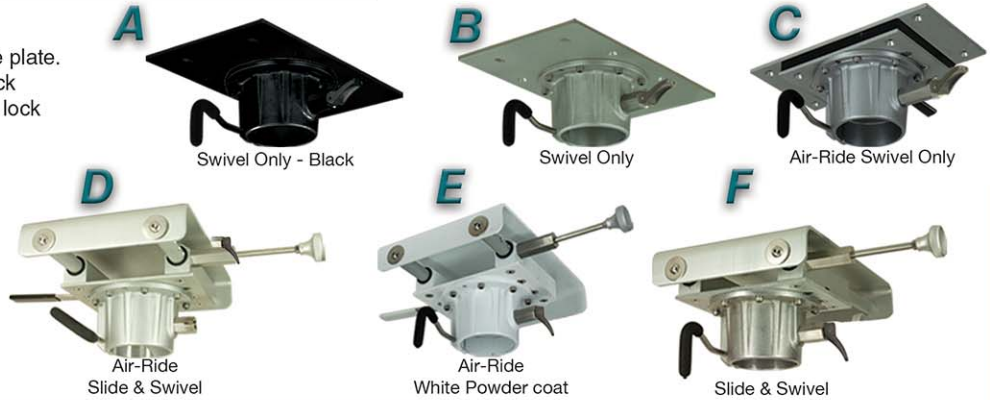

## LOW PROFILE WORKHORSE SLIDE & SWIVEL

OEM IMAGE	PART NUMBER	DESCRIPTION	PACK QUANTITY	ABYC
A.	3100656-01	Low Profile Slide & Swivel w/ 4" Mount	1 Pack	AD
B.	3100676-L	Low Profile Slide w/ 4" Swivel	1 Pack	AD
B.	3100676-LS	Short Low Profile Slide w/ 4" Swivel	1 Pack	AD
B.	3100676-LARS	Short Low Profile Slide w/ 4" Air-Ride Swivel	1 Pack	AD
C.	3100675-L	Heavy Duty Towel Bar Slide w/ 4" Swivel	1 Pack	AD

Low Profile Slide with front activated towel bar  
handle for slide activation mounted to 4" Workhorse  
Swivel.

Short Low Profile Used on Bolster Seats.  
Mounts to any 4" Seat Pedestal.

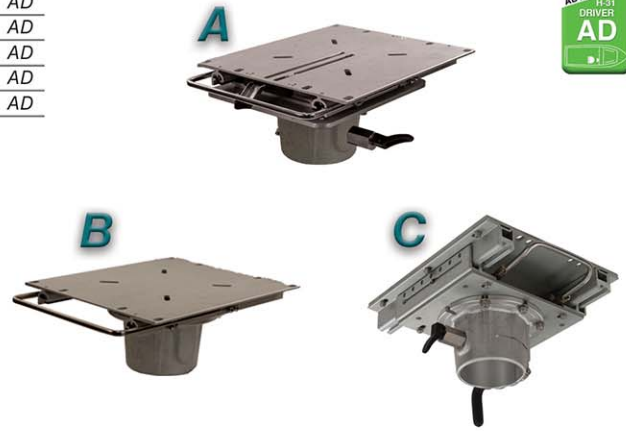

Elite Slides Are Rated  
ABYC Class H-31 AD



## ELITE SLIDE & SWIVEL

OEM IMAGE	PART NUMBER	DESCRIPTION	FINISH	PACK QUANTITY	ABYC
A.	3100460-LE1	Elite Slide & Swivel	Anodized	4 Bulk	AD

8-1/4" x 13" seat mounting platform. Anodized slide and polished  
post mount, fits over 4" pedestals. Locks and tightens securely to  
prevent wobble. Large pivot area ensures stability, rotates 360°.  
Slide travels 5-3/8" fore and aft. Adds 1-1/2" to height of pedestal.

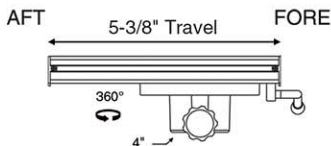

Elite Slides Are Rated  
ABYC Class H-31 AD



## ALUMINUM ADJUSTABLE MAINSTAY PEDESTALS

IMAGE	PART NUMBER	ADJUSTS	FINISH	PACK QUANTITY	ABYC
A.	1270340-P	13-1/2" to 18"	Polished Finish	1 Retail	AD
A.	1270346-P	18" to 28"	Polished Finish	1 Retail	AD
A.	1270350-P	22" to 32"	Polished Finish	1 Retail	AD
A.	1270354-P	26" to 36"	Polished Finish	1 Retail	AD
A.	1270350-W	22" to 32"	White Powder Coat	1 Retail	AD
B.	1270370-W	6-3/8" to 14-1/4"	White Powder Coat	1 Retail	AD

4" adjustable pedestal with 12" round base. Air-powered height adjustment. 650 Newton air cylinder provides lift. Available as polished aluminum or white powder coat finish.

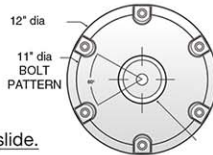

**3100550-SS Center floor slide.**  
Allows seat to move easily up to 35-1/2" side-to-side between stations. Platform with pre drilled holes to accept standard 12" base.



Polished Finish



White Powder Coat

Mainstay Pedestals Are Rated ABYC Class H-31 AD



## ELITE FIXED HEIGHT PEDESTALS

IMAGE	PART NUMBER	ADJUSTS	FINISH	PACK QUANTITY	ABYC
A.	1450012-P	12"	Polished	1 Retail	AD
B.	1450014-P	14"	Polished	1 Retail	AD
C.	1450018-P	18"	Polished	1 Retail	AD
D.	1450022-P	22"	Polished	1 Retail	AD
E.	1450024-P	24"	Polished	1 Retail	AD
F.	1450028-P	28"	Polished	1 Retail	AD
G.	1450030-P	30"	Polished	1 Retail	AD

4" aluminum pedestal with 12" round base, polished finish. Pedestal is sized and pressed into base, then rim welded for stability.

- Posts are .213" thick aluminum.

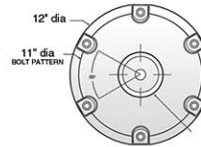

Elite Pedestals Are Rated ABYC Class H-31 AD



4" SERIES

## STAINLESS STEEL PEDESTALS

IMAGE	PART NUMBER	ADJUSTS	FINISH	PACK QUANTITY	ABYC
A.	1450626-SSP	26"	316 Stainless Steel	1 Retail	AD
A.	1450630-SSP	30"	316 Stainless Steel	1 Retail	AD
B.	1270640-SS	13-1/2" to 18"	316 Stainless Steel	1 Retail	AD
B.	1270646-SS	18" to 28"	316 Stainless Steel	1 Retail	AD
B.	1270650-SS	22" to 32"	316 Stainless Steel	1 Retail	AD

4" locking fixed height pedestal with 12" round base. 316 stainless steel, with #8 mirror finish. Rim welded to provide maximum strength. Available in a variety of heights.

Use with any 4" Seat Mount.

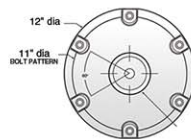

Fixed



Adjustable

Fixed Height Pedestals Are Rated ABYC Class H-31 AD



## 4" EZ-RIDE PEDESTAL

RETAIL IMAGE	PART NUMBER	DESCRIPTION	PACK QUANTITY	ABYC
A.	1080117	4" EZ-RIDE WAVE DAMPENING PEDESTAL	1 Pack	AD
B.	1080115	4" EZ-RIDE THRU-DECK PEDESTAL	1 Pack	AD

(A.) Proven mechanical spring and shock technology in a traditional pedestal configuration.

- Thick wall (.213) posts.
- Allows 5-1/2" of vertical travel

(B.) Proven mechanical spring and shock technology in a traditional pedestal configuration

- Polished brite dip aluminum pedestal with 12" round base
- Thick wall (.213) posts.
- Allows 5-1/2" of vertical travel

A: 500kg/175lbs per inch rating.

Wave dampening pedestal reduces the impact caused by harsh waves.

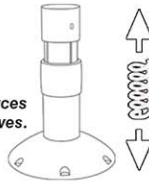

EZ-Ride Pedestals Are Rated ABYC Class H-31 AD



## OFFSHORE 4" PACKAGE

RETAIL IMAGE	PART NUMBER	DESCRIPTION	PACK QUANTITY
A.	1457545	4" Fixed Height Helm Pedestal Package	1 PACK

Heavy-duty 4" Workhorse slide & swivel, anodized finish. 4" fixed height brite dip pedestal with 12" round floor base. Helmsman flip-up footrest, flips-up out of the way.



24" Fixed Height Pedestal.

Overall Height 27-1/2"



4" SERIES

## OFFSHORE 4" ADJUSTABLE

RETAIL IMAGE	PART NUMBER	DESCRIPTION	PACK QUANTITY
A.	1276548	4" Air-Ride Helm Pedestal Package	1 PACK

Heavy-duty 4" air-ride Mariner II slide & swivel, anodized finish. 4" brite dip pedestal with 12" round polished floor base. Seat mounting footrest offers adjustable height and flips-up out of the way.



Pedestal Adjusts 18" to 26"

Overall Height 22" to 30"



# 4" Series

## INSHORE LE1 PACKAGE

IMAGE	PART NUMBER	DESCRIPTION	PACK QUANTITY
A.	1255595-NC	INSHORE LE1 PEDESTAL PACKAGE	1 PACK

Heavy-duty adjustable Mainstay package, adjusts from 13-1/2" to 19". Includes locking Trac-Lock™ air-ride slide & swivel. Half-round stainless steel footrest, 316 electro polished stainless steel. Black powder coated 5 legged deck base.

Pedestal Adjusts  
13-1/2" to 19"

Overall Height  
20" to 27"



## INSHORE RS2 PACKAGE

IMAGE	PART NUMBER	DESCRIPTION	PACK QUANTITY
A.	1455580-NC	INSHORE RS2 PEDESTAL PACKAGE	1 PACK

Locking Workhorse swivel mount, anodized finish. 4" fixed height pedestal with 12" round floor base and high-strength polished aluminum finish. 316 electro polished stainless steel 28" round footrest. Black powder coated 5 legged deck base.

18" Fixed Height  
Pedestal

Overall Height  
25-1/2"

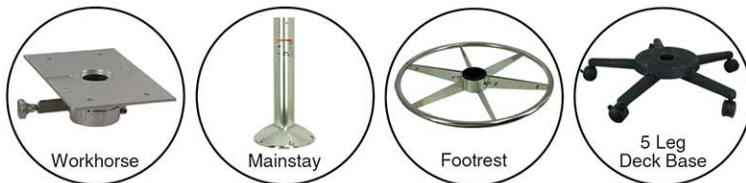

## INSHORE LX2 PACKAGE

IMAGE	PART NUMBER	DESCRIPTION	PACK QUANTITY
A.	1275580-NC	INSHORE LX2 PEDESTAL PACKAGE	1 PACK

Air-ride locking Workhorse swivel mount, anodized finish. 4" pedestal with 12" round floor base, and high-strength polished aluminum finish. 28" round footrest, 316 electro polished stainless steel. Black powder coated 5 legged deck base.

Pedestal Adjusts  
13-1/2" to 18"

Overall Height  
23" to 27-1/2"





# ABOUT MOUNTING SYSTEMS

Springfield Marine offers Our wide range of Mounting Systems are designed for low profile decks with features that include both swivel and slide for passenger or driver's seat positions. Plus we offer a range of recreational systems for Jon Boats and other small crafts. ABYC H-31 A rated to B rated.



BENCH SLIDES • SWIVELS • SEAT CLAMPS • MOUNTING PLATES • SLIDE RAILS • PEDESTALS

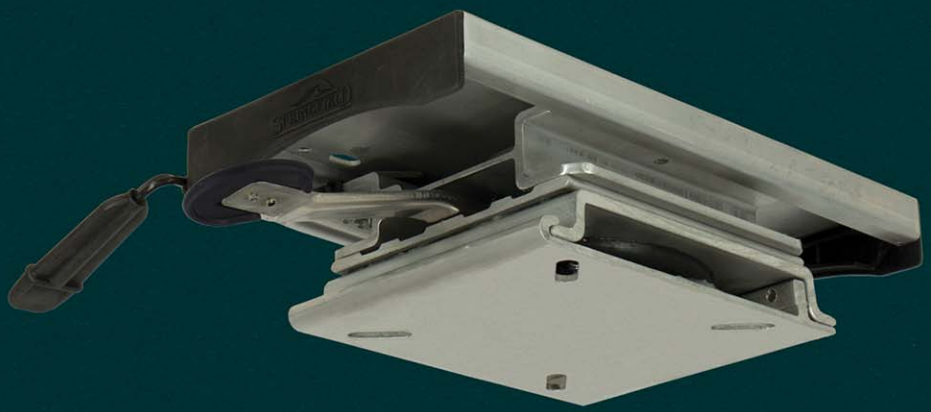

MOUNTING SYSTEMS

# Mounting Systems

## TRU-LOCK 1000

Tru-Lock is Rated  
ABYC Class H-31 AD



RETAIL				
IMAGE	PART NUMBER	DESCRIPTION	PACK QUANTITY	ABYC
A.	1100360	Tru-Lock 1000 Slide & Swivel	1 Retail	AD

OEM				
IMAGE	PART NUMBER	DESCRIPTION	PACK QUANTITY	ABYC
A.	3100360	Tru-Lock 1000 Slide & Swivel	8 Bulk	AD
B.	3100360-EXTL	Tru-Lock 1000 Left Extended Handle	8 Bulk	AD

Retail packages are packed in box with 4 color label

Large 7-1/4" W x 13" D x 3-1/2" H platform. Travels 5-1/4" fore and aft with 8 locking positions. Large pivot area for stability. Rotates 360°, pivot handle rotates with chair. Easy to install and remove with separate lower mounting plate. 4" x 5-5/8" mounting pattern. Universal mounting pattern: 5x5 & 5x12

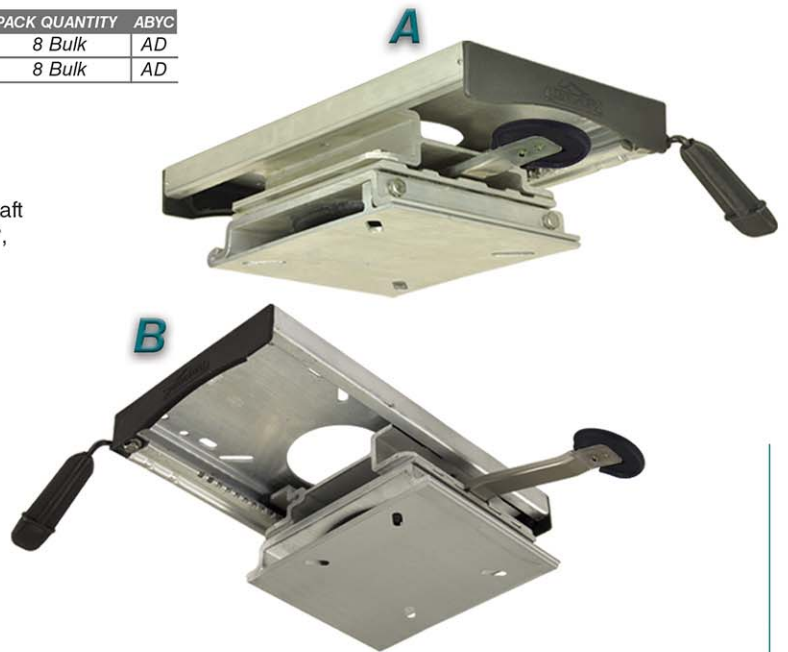
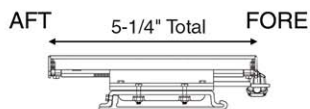

## ELITE 100 SLIDE & SWIVEL

Elite Slides Are Rated  
ABYC Class H-31 AD



OEM				
IMAGE	PART NUMBER	DESCRIPTION	PACK QUANTITY	ABYC
A.	3100401	Elite 100 Slide & Swivel Mount	6 Pack	AD

Unique design allows easy installation, made from high-strength aluminum construction. 8-1/2" x 13" seat mount platform, travels 5-3/8" for and aft. 8 locking positions. Overall height is 3.5"

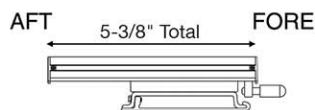

## HEAVY-DUTY FRONT LEVER & ELECTRIC SLIDES

OEM IMAGE	PART NUMBER	DESCRIPTION	PACK QUANTITY	ABYC
A.	3100545	Front Lever Heavy-Duty Slide	4 Pack	AD
B.	3100545-EW	Heavy-Duty 52" Wide, Electric Slide	1 Pack	AD
B.	3101545-EW	Heavy-Duty 31-1/2" Wide, Electric Slide	1 Pack	AD
B.	3100544-E1	Heavy-Duty 4" Short Plate, Electric Slide	1 Pack	AD

### (A.) Front Lever Slides:

- High-strength anodized aluminum construction.
- Travels fore and aft 6" on heavy-duty rails.
- Double latch tow bar slide. Includes top and bottom mounting plate.

### (B. & C.) Electric Heavy-Duty Slide:

- High-strength anodized aluminum construction.
- Electric motor operates on 12 volts DC power.
- Smooth and quiet operation.



Front Lever Slide



Electric - Wide Slide



Electric - Short Plate

Front Lever Slides Are Rated ABYC Class H-31 AD



## LOW PROFILE SLIDES

OEM IMAGE	PART NUMBER	DESCRIPTION	PACK QUANTITY	ABYC
A.	3100045	Quick Mount for Low Profile Slide	10 Pack	-
E.	3100047-BLK	Low Profile Deck Bracket - Black	20 Pack	-
B.	3100645-S	Low Profile Slide Short w/ Mount	10 Pack	AD
B.	3100646	Low Profile Slide	10 Pack	AD
B.	3100647	Low Profile Short Handle w/ Mounting Plate	10 Pack	AD
D.	3100656	Low Profile Slide & Swivel	4 Pack	AD
C.	3100661-M	Heavy Duty Low Profile Slide w/ Stop	10 Pack	AD
F.	3100665-01	Low Profile Slide Rails 2 Piece	10 Pack	AD

### (A. & B.) Low Profile Slide & Quick Mount

- High-strength anodized aluminum construction
- Stainless steel front activation handle bar
- Quick mount for easy installation
- Travels 5" fore and aft
- Only 1.25" thick
- 3100045 **MOUNT** & 3100646 **SLIDE** work together

### (C.) Heavy Duty Low Profile Slide Rails Cast w/ Plate

- High-strength anodized aluminum
- Slides fore and aft on heavy-duty rails with nylon glides for smooth travel
- 3100047-BLK Mount & 3100661-M Slide Work Together.



Quick Mount for Low Profile Slide



Low Profile Slides Are Rated ABYC Class H-31 AD



Low Profile Slide



Deck Bracket - Black



Heavy Duty Low Profile Slide



Low Profile Slide & Swivel



Low Profile 2-Piece Locking

## UNIVERSAL TRAC-LOCK™ SLIDE

RETAIL IMAGE	PART NUMBER	DESCRIPTION	PACK QUANTITY	ABYC
A.	1100300	Universal Trac-Lock™ Slide	6 Retail	AD

OEM IMAGE	PART NUMBER	DESCRIPTION	PACK QUANTITY	ABYC
A.	3100300	Universal Trac-Lock™ Slide	10 Bulk	AD
A.	3100300-SM	Universal Trac-Lock™ Slide, Short	10 Bulk	AD

Retail packages are packed in clamshell with 4 color label

Large 7-1/4" x 13" high, 0-degree platform. Travels 5-1/4" fore and aft. High-strength anodized aluminum. Can be used as box or pedestal mount. Adds 2" to height of seat. (PN: 3100300-SM For Bolster seats).

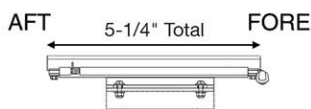

Universal Slides Are Rated ABYC Class H-31 AD



# Mounting Systems

## QUICK SEAT MOUNT

Quick Seat Mounts Are Rated ABYC Class H-31 B



RETAIL				
IMAGE	PART NUMBER	DESCRIPTION	PACK QUANTITY	ABYC
A.	1100016	Quick Seat Mount & Rails - Travels 27" Side to Side	6 Retail	AD
B.	1100017	Quick Seat Mount & Rails - Travels 6.5" Side to Side	6 Retail	AD
OEM				
IMAGE	PART NUMBER	DESCRIPTION	PACK QUANTITY	ABYC
C.	3100036	Quick Release Seat Mount - Anodized	20 Bulk	AD
C.	3100036-BLK	Quick Release Seat Mount - Black Anodized	20 Bulk	AD
D.	3100038-BLK	15" Black Anodized Rail, With End Caps	20 Bulk	AD
E.	3100037	32" Anodized Rail	20 Pack	AD
E.	3100039	44" Satin Anodized Rail Only	20 Pack	AD
F.	3100034	18" Quick Release Bracket Clamp	20 Bulk	AD

Easy to install and remove from boat. Bracket allows seat to slide side to side for comfort and convenience. Locking mechanism prevents tipping forward in sudden stop situations. Commonly used on Tiller style boats.



A  
27" Quick Mount



B  
6.5" Quick Mount

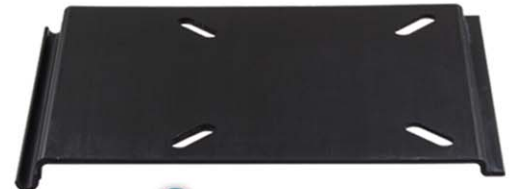

C  
Black Anodized Mounting Plate



D  
15" Black Anodized Rail w/ End Caps



F  
Quick Release Bracket Clamp



E  
Satin Anodized Rail

## UNIVERSAL MOUNTING PLATE

OEM			
IMAGE	PART NUMBER	DESCRIPTION	PACK QUANTITY
A.	3100207	Mounting Plate	10 Bulk

Adapts a swivel mount to fit most seat mount patterns. High-strength aluminum. Use with any Springfield Marine swivel. Adds structural support to rotational molded seats and other plastic seat bottoms.

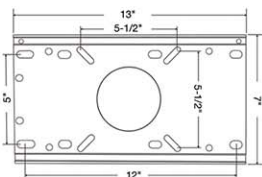

A

## SEAT SUSPENSION SYSTEM

RETAIL				
IMAGE	PART NUMBER	DESCRIPTION	PACK QUANTITY	ABYC
A.	1840220	Seat Suspensions System	6 Pack	B

OEM				
IMAGE	PART NUMBER	DESCRIPTION	PACK QUANTITY	ABYC
A.	3840220	Seat Suspension System	10 Bulk	B

Seat Suspension System Is Rated ABYC Class H-31 B



Retail packages are packed in box with 4 color label

7" x 8-1/2" x 2-1/2" high. High-strength aluminum. Heavy-duty 515 springs provide a comfortable ride.

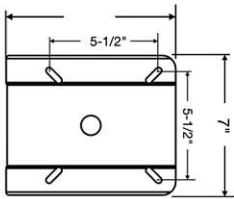

## SLIDE RAILS

OEM			
IMAGE	PART NUMBER	DESCRIPTION	PACK QUANTITY
A.	3100205	2-Piece Chair Slide Rails	10 Bulk
B.	3100205-M	2-Piece Chair Slide Rails - Bent Handle	10 Bulk

Stainless steel slide rails are available as 2-piece set, with straight or bent handle. Includes 1-1/8" mounting studs.

Slide rails travel 6" fore and aft.



## HEAVY-DUTY SLIDE RAILS

OEM					
IMAGE	PART NUMBER	DESCRIPTION	STUDS	PACK QUANTITY	ABYC
A.	3100534-L	2-Piece Slide Rails, Locking	-	10 Bulk	AD
B.	3100534-L3M	3-Piece Slide Rails, Locking	-	10 Bulk	AD
C.	3100534-LSH	2-Piece Slide Rails, Short	-	10 Bulk	AD
D.	3100534-S	2-Piece Slide Rails, Locking	Included	10 Bulk	AD
E.	3100537-L3	3-Piece Slide Rails, Locking	-	10 Bulk	AD
F.	3100548	2-Piece Slide Rails, Non Locking	-	10 Bulk	AP
G.	3100665-01	Low Profile 2-Piece Slide Rails, Locking	-	10 Bulk	AD

Heavy-Duty Slide Rails Are Rated ABYC Class H-31 AD



Slide rails for large seats any where in the boat. High-strength aluminum to withstand all conditions. Travels 7" fore and aft.

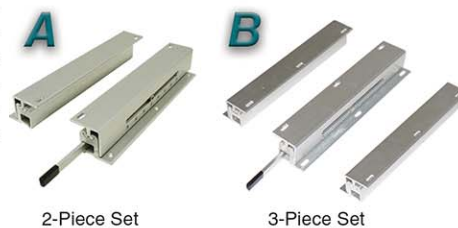

# Mounting Systems

## UNIVERSAL TRACK-LOCK™ W/12-WAY SWIVEL

RETAIL				
IMAGE	PART NUMBER	DESCRIPTION	PACK QUANTITY	ABYC
A.	1100318	Universal With E-Coat Swivel	1 Retail	AD
B.	1100319	Universal With Stainless Steel Swivel	1 Retail	AD

OEM				
IMAGE	PART NUMBER	DESCRIPTION	PACK QUANTITY	ABYC
A.	3100318	Universal With E-Coat Swivel	10 Bulk	AD
B.	3100319	Universal With Stainless Steel Swivel	10 Bulk	AD

Large 7-1/4" x 13" x 3" high, 0-degree platform. Travels 5-1/2" fore and aft. Mounted on 12-Way swivel, rotates°. Swivel available in mild steel with e-coat finish or stainless steel.

Patent #5,782,451

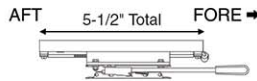

Universal Slides Are Rated  
ABYC Class H-31 AD



## 12-WAY LOCKING SWIVELS

RETAIL					
IMAGE	PART NUMBER	DESCRIPTION	FINISH	PACK QUANTITY	ABYC
A.	1100018	0-Degree Locking Swivel	E-Coat	1 Retail	AD
B.	1100019	0-Degree Locking Swivel	Stainless Steel	1 Retail	AD

OEM					
IMAGE	PART NUMBER	DESCRIPTION	FINISH	PACK QUANTITY	ABYC
A.	3100018-01L	12 Way Swivel w/ Lockout	E-Coat	20 Bulk	AD
A.	3100018	0-Degree Locking Swivel	E-Coat	20 Bulk	AD
B.	3100019	0-Degree Locking Swivel	Stainless Steel	20 Bulk	AD

Retail packages are packed in clamshell with 4 color label  
6-3/4" square x 1-1/8" high, with 4 hole mounting pattern.  
Locking swivel, rotates 360°. Available in two finishes:  
e-coat finish or stainless steel. Handle length: 6.5"

Patent #5,782,451

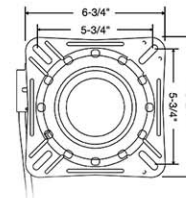

12-Way Swivels Are Rated  
ABYC Class H-31 AD



## NON-LOCKING SWIVELS

RETAIL					
IMAGE	PART NUMBER	DESCRIPTION	FINISH	PACK QUANTITY	ABYC
A.	1100007	0-Degree Non-Locking Swivel	E-Coat	1 Pack	B
B.	1100009	0-Degree Non-Locking Swivel	Stainless Steel	1 Pack	B
A.	1100007-PDQ	7"x7" Square Swivel	E-Coat	6 Pack	B

OEM					
IMAGE	PART NUMBER	DESCRIPTION	FINISH	PACK QUANTITY	ABYC
A.	3100007	0-Degree Non-Locking Swivel	E-Coat	20 Bulk	B
B.	3100009	0-Degree Non-Locking Swivel	Stainless Steel	20 Bulk	B

Retail packages are packed in clamshell with 4 color label  
6-3/4" square x 1-1/8" high, with 4 hole mounting pattern.  
0-degree non-locking swivel, rotates 360°.  
Available in two finishes: e-coat finish or stainless steel.  
(PN: 1100007-PDQ Bulk Packed 6 to shelf tray for retail).

Patent #5,782,451

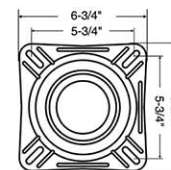

Non-Locking Swivels Are  
Rated ABYC Class H-31 B



## PRO-TILT SEAT MOUNT

RETAIL IMAGE	PART NUMBER	DESCRIPTION	FINISH	PACK QUANTITY	ABYC
A.	1780010	Pro-Tilt Seat Mount	E-Coat	6 Retail	B

Retail packages are packed in box with 4 color label

7" x 7" seat mount with 4 mounting holes.  
Spring-loaded locking mechanism, tit angles: 3°, 15°, 25°, 30°, 40°, & 50°  
E-coated mild steel to resist corrosion

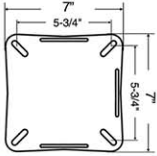

Pro-Tilt  
Rated ABYC Class H-31 B



Closed

## REMOVABLE 7" X 7" SEAT BRACKET

RETAIL IMAGE	PART NUMBER	DESCRIPTION	PACK QUANTITY	ABYC
A.	1100115	Removable Seat Bracket & Swivel	6 Retail	B
A.	1100015	Removable Seat Bracket 7" x 7"	6 Retail	B

OEM IMAGE	PART NUMBER	DESCRIPTION	PACK QUANTITY	ABYC
B.	3100015-1	Removable Seat Bracket	20 Bulk	B

Retail packages are packed in clamshell with 4 color label

7" x 7" removable seat bracket.  
Non-locking seat swivel, rotates 360°.  
Swivel has e-coat finish to resist corrosion.

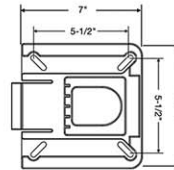

Removable Brackets Are  
Rated ABYC Class H-31 B



## HEAVY-DUTY SEAT SWIVEL

RETAIL IMAGE	PART NUMBER	DESCRIPTION	PACK QUANTITY	ABYC
A.	1100050	Non-Locking Swivel	6 Retail	B
B.	1100050-L	Locking Swivel	6 Retail	AD
C.	1100550-L	Locking Slide & Swivel	1 Retail	AD

OEM IMAGE	PART NUMBER	DESCRIPTION	PACK QUANTITY	ABYC
A.	3100050	Non-Locking Swivel	20 Bulk	B
B.	3100050-L	Locking Swivel	20 Bulk	B
C.	3100550-L	Locking Swivel & Swivel	10 Bulk	B

7" x 7" swivel with 4 mounting hole pattern 0-degree tilt  
Powder coat finish to resist corrosion. Rotates 360°.  
Slide travels 5-1/4" fore and aft.

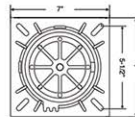

Heavy-Duty Swivels Are  
Rated ABYC Class H-31 AD & B



Slide travels 5-1/4" fore and aft.

(B. & C.) 4 Locking positions - pull handle up to rotate.

## JON BOAT SEAT CLAMP

RETAIL IMAGE	PART NUMBER	DESCRIPTION	ADJUSTS	PACK QUANTITY	ABYC
A.	1100012	Economy Seat Clamp	8" to 19"	6 Retail	B
A.	1104010	Jon Boat Seat Clamp	8" to 20-1/2"	6 Retail	B
B.	2100097	Jon Boat Safety Clip	-	6 Retail	-

Retail packages are packed in box with 4 color label

Adjustable Seat Clamp to fit most bench seats. E-coated steel to resist corrosion.

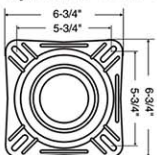

Jon Boat Seat Clamps Are  
Rated ABYC Class H-31 B



# Mounting Systems

## ECONOMY FIXED HEIGHT PEDESTALS

RETAIL IMAGE	PART NUMBER	DESCRIPTION	FINISH	PACK QUANTITY	ABYC
A.	1561105	7"	E-Coat	6 Retail	B
B.	1561106	13"	E-Coat	6 Retail	B

7" x 7" square base and seat mount. Rugged, all steel construction. E-coat corrosion resistant finish for all weather conditions. For use with standard boat seats.

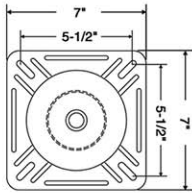

Economy Pedestals Are Rated ABYC Class H-31 B



## ECONOMY ADJUSTABLE PEDESTALS

RETAIL IMAGE	PART NUMBER	DESCRIPTION	FINISH	PACK QUANTITY	ABYC
A.	1561107	12" to 18"	E-Coat	6 Retail	B

Retail packages are packed in box with 4 color label

7" x 7" square base and seat mount. Rugged, all steel construction. E-coat corrosion resistant finish for all weather conditions. Adjusts from 12" to 18" in 2" increments. For use with standard boat seats.

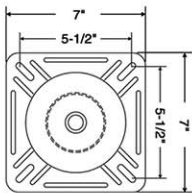

Economy Pedestals Are Rated ABYC Class H-31 B



## BELLE ADJUSTABLE PEDESTAL

RETAIL IMAGE	PART NUMBER	DESCRIPTION	FINISH	PACK QUANTITY	ABYC
A.	1440248	13" to 17"	Powder Coat	1 Retail	B

Retail packages are packed in box with 4 color label

Adjustable post with 10" round base and Trac-Lock™ seat mount. Rotates 360°, easy to grip handles. Fits standard boat seats. Corrosion resistant powder coat finish. 5x5 Seat mount pattern.

Patent #5,758,856

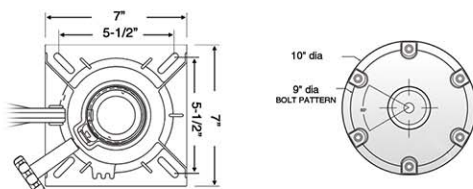

Springfield Belle Pedestals Are Rated ABYC Class H-31 B





## ABOUT TABLES & GRILLS

Springfield Marine's Tables & Grills enhance your on the water dining experience. Designed to be used on board, our grills and tables allow you to extend your boating pleasure by reducing your need to go ashore. At mealtime or snack time, simply set up, cook, and enjoy.

Our grills and tables are available in a wide range of styles to suit your needs. To add to your convenience, all grills and tables are removable for easy storage to keep your lounging area spacious and free for other activities when not in use.

Springfield Marine reminds you to always use caution whenever operating a barbecue grill; especially on the water.

BBQ GRILLS • TABLE PACKAGES • TABLE TOPS • POSTS • MOUNTS • BASES • ACCESSORIES



TABLES & GRILLS

# Tables & Grills

## GRILL PACKAGES

RETAIL		
IMAGE	PART NUMBER	DESCRIPTION
A.	1940049	Grill Only
B.	1940052	Grill with Thread-Lock™
C.	1940054	Grill with Multi-Fit Mount Kit
D.	1940057	Grill with Trailer Hitch Mount
E.	2100184	Rail Mount with Multi-Fit Kit

Retail packed in box with 4 color label  
 All models convert to table top grill.  
 189 sq. in. grill cooking surface.  
 130 sq. in. griddle surface on top of lid.  
 12,000 BTU rating.  
 Use with a 1lb propane tank (not included).



Rail Mount

Multi-Fit Kit  
 adapt to the following sizes:



Grill Dimensions:  
 22-3/4" W x 12" D x 7-1/2" H

Legs fold upward to be used as a carry handle.



1" Round Rail 1-1/4" Rail 1-1/2" Rail

Rail Mount With Multi-Fit Kit



## GRILL SERVICE PARTS

RETAIL		
IMAGE	PART NUMBER	DESCRIPTION
A.	2100145	Cooking Grate
B.	2100146	Heat Transfer Plate
C.	2100148	Stainless Steel Burner
D.	2100149	Gas Regulator
E.	2100151	Carrying handles
F.	2100194	Oil Drain Pan
G.	2100147	Thread-Lock™ Post 2-Piece

Service and replacement parts for bbq grill packages.

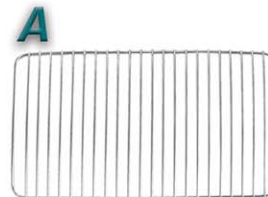

Cooking Grate



Heat Transfer Plate



Stainless Steel Burner



Gas Regulator



Carrying Handles



Oil Drain Pan



Thread-Lock™ 2-Piece Post

## TABLE TOPS

RETAIL					
IMAGE	PART NUMBER	TABLE TOP	UMBRELLA SOCKET	COLOR	PACK QUANTITY
A.	1670002	Round	No	White	1 Retail
A.	1670002-U	Round	Yes	White	1 Retail
A.	1670002-T	Round	No	Tan	1 Retail
B.	1670006	Oval	No	White	1 Retail
B.	1670006-U	Oval	Yes	White	1 Retail
B.	1670006-GB	Oval	Yes	Grey	10 Bulk
B.	1670006-TB	Oval	Yes	Tan	10 Bulk
C.	1670008	Rectangular	No	White	1 Retail
C.	1670008-TB	Rectangular	No	Tan	10 Bulk
D.	1670009	Party Platter	No	White	1 Retail
D.	1670009-GB	Party Platter	No	Grey	10 Bulk
E.	3760040	Table Loom	No	Chrome	1 Retail
F.	7100170	Socket Cover	No	Black	100 Bulk

Light-weight, molded heavy-duty marine grade plastic.  
Available in 4 shapes and sizes with drink holders.  
Available as plain or with umbrella socket.

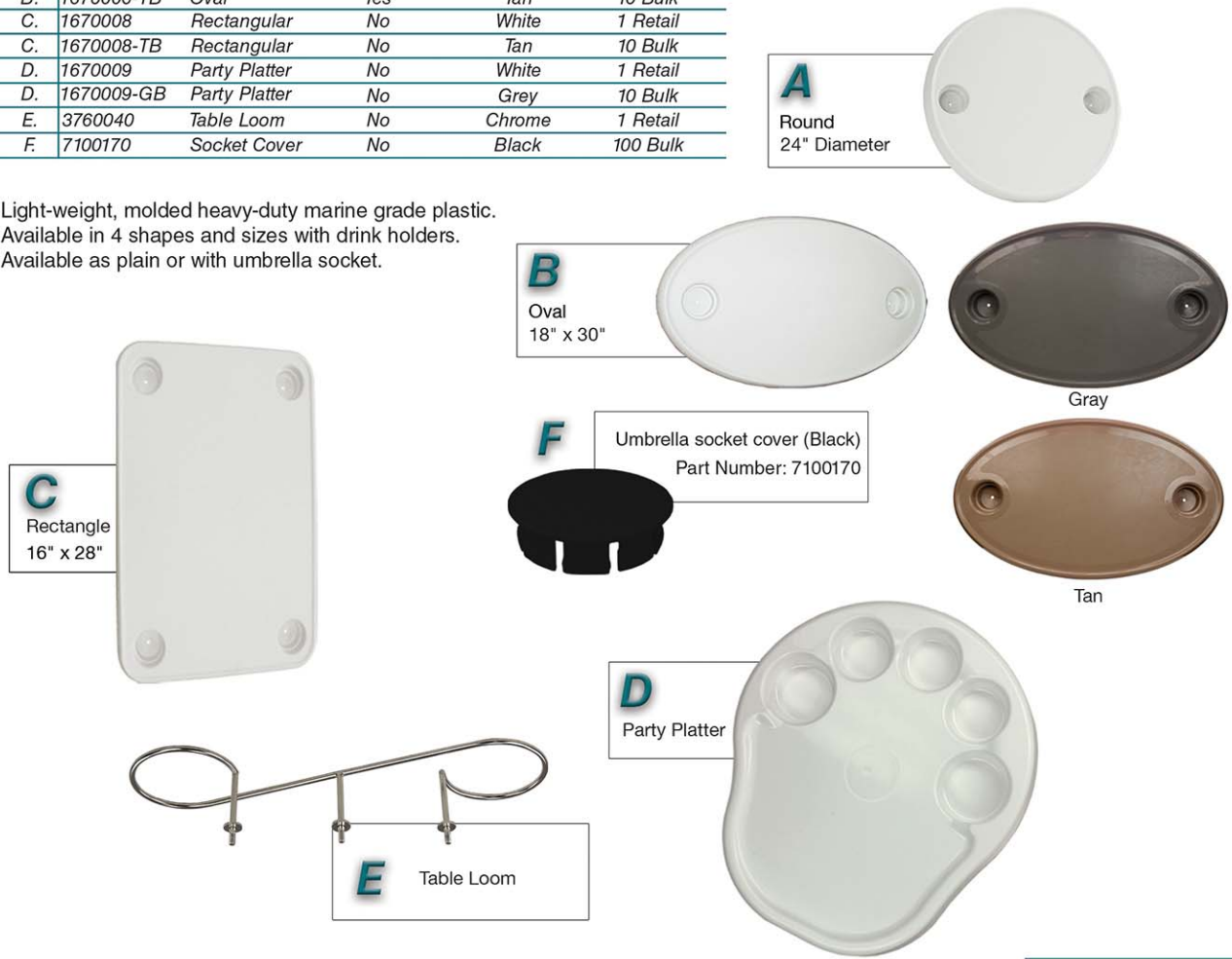

## PARTY PLATTER PACKAGE

RETAIL				
IMAGE	PART NUMBER	TABLE TOP	UMBRELLA SOCKET	PACK QUANTITY
A.	1690901	Party Platter	No	1 Retail

Package Includes:

- Party Platter table top, 5 cup holders
- Plastic table mount built into table top
- 2-Piece anodized aluminum locking Thread-Lock™ post
- Thread-Lock™ black plastic surface mount base



Stows Easily To Fit In Most Compartments!



# Tables & Grills

## THREAD-LOCK™ TABLE PACKAGES

RETAIL					
IMAGE	PART NUMBER	TABLE TOP	TABLE SIZE	COLOR	PACK QUANTITY
A.	1690102	Round	24"	White	1 Retail
B.	1690106	Oval	18" x 30"	White	1 Retail
C.	1690107	Rectangle	16" x 28"	White	1 Retail

Packages include the following parts:

- Table top, available as round, oval, or rectangular
- 27" Threadlock™ Table Post [3691027](#)
- Table Base: [3690001-SL](#)
- Table Mount: [3660704-L](#) Surface Mount.



## STOWABLE TABLE PACKAGES

RETAIL					
IMAGE	PART NUMBER	TABLE TOP	TABLE SIZE	COLOR	PACK QUANTITY
A.	1690202	Round	24"	White	1 Pack
B.	1690206	Oval	18" x 30"	White	1 Pack
C.	1690207	Rectangle	16" x 28"	White	1 Pack

Packages include the following parts:

- Table top, available as round, oval, or rectangular
- Table Post: [3660527](#)
- Table Mount: [3660018](#)
- Table Base: [3660017](#) Recess Mount.



## 3- STAGE TABLE PEDESTALS

### Gas Powered 3-Stage Aluminum Pedestals

IMAGE	PART NUMBER	ADJUSTS	FINISH	PACK QUANTITY
A.	1660230	12-3/4"; 20"; 28"	Anodized	1 Retail
B.	1660230-BLK	12-3/4"; 20"; 28"	Black Anodized	1 Retail
A.	1660231	14"; 20"; 28"	Anodized	1 Retail
C.	1660232	14"; 20"; 28"	Brite Dip	1 Retail
D.	1660232-KP1	15" to 28"	Brite Dip	1 Retail
C.	1660236	16" to 30"	Brite Dip	1 Retail

Gas Powered Pedestals with 12-1/2" table mount and 12" dia. floor base with 11" hole pattern for added stability.

Made from high-strength aluminum, available in a variety of heights and finishes.

3-Stage table pedestals are designed to bring maximum strength and support to your dining experience.



3-Stage sturdy adjustable table pedestals



Use with Trac-Lock™  
2-7/8" chrome swivel  
PN: 3100021-CR1



Adjusts 15-1/2" to 28" with swivel  
Use with threaded 4" round KingPin™  
base PN: 3630025 (sold separately)

## SIDE TABLE MOUNTS

IMAGE	PART NUMBER	DESCRIPTION	FINISH	PACK QUANTITY
A.	3670702	Stainless Steel Side Table Post - Post Only	Polished	10 Bulk
B.	3670703	Side Table Post 2-3/8" - Post Only	Anodized	10 Bulk
C.	3760710-P	Side Table Mount Reciever	Polished	10 Bulk
D.	3660900	Side Table Mount Reciever	E-Coat	20 Bulk
B.	3660018	Table Mount 2-7/8"	Anodized	20 Bulk
A.	3640033-PPT	Table Mount	Stainless Steel	20 Bulk

Table Mount, Table Post and Reciever are sold separate.



Stainless Steel Side Table Post



Side Table Mount Reciever - E-Coat

# Tables & Grills

## ELECTRIFIED TABLE BASE

RETAIL				
IMAGE	PART NUMBER	DESCRIPTION	PACK QUANTITY	
A.	1690727-SL	Thread-Lock™ Pedestal	1 Pack	

Thread-Lock™ Pedestal Package Includes:

- 2-3/8" diameter anodized aluminum fixed height post with latch
- High-strength black plastic table mount
- 7" aluminum surface mount floor base with a 5-3/4" hole pattern and satin finish
- 12 Volt Power
- USB Connection
- LED illumination



Table Mount w/  
LED & USB



Thread-Lock Base  
w/ Electric Connection



Post Top w/  
Electric Connection

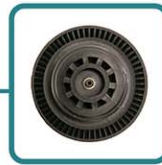

Post Thread-Lock w/  
Electric Connection

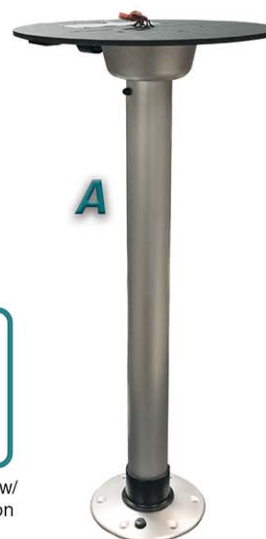

A

## THREAD-LOCK™ DOUBLE LOCKING POSTS

RETAIL				
IMAGE	PART NUMBER	FIXED HEIGHT	FINISH	PACK QUANTITY
A.	1692027-L	27"	Anodized	6 Retail

OEM				
IMAGE	PART NUMBER	FIXED HEIGHT	FINISH	PACK QUANTITY
A.	3692027-L	27"	Anodized	20 Bulk
A.	3692029-L	29"	Anodized	20 Bulk

A



2-3/8" double locking posts.  
Smooth anodized finish or fluted brite dip finish.  
Use with any 2-3/8" Stowable table mount (sold separately).  
Works with any Thread-Lock™ table base (sold separately).

## THREAD-LOCK™ UNI-LOCK POSTS

RETAIL				
IMAGE	PART NUMBER	TABLE TOP	UMBRELLA SOCKET	PACK QUANTITY
A.	1690727-SL	Plastic	Satin	1 Pack

OEM				
IMAGE	PART NUMBER	FIXED HEIGHT	FINISH	PACK QUANTITY
B.	3691014-L	14"	Anodized	20 Bulk
B.	3691025-L	25"	Anodized	20 Bulk
C.	3691027	27"	Anodized	20 Bulk
B.	3691027-L	27"	Anodized	20 Bulk
B.	3691028-L	28"	Anodized	20 Bulk
D.	3692027-LU	27"	Anodized	20 Bulk

2-3/8" Uni-Lock posts.  
Use with Uni-Lock table mount #3660704-L (sold separately).  
Works with any Thread-Lock™ table base (sold separately).



A



B



C



D

for use with  
Umbrella

Not  
Tapered

## THREAD-LOCK™ ADJUSTABLE PEDESTAL

OEM IMAGE	PART NUMBER	ADJUSTS	FINISH	PACK QUAINTIT
A.	3692700	21-1/2" to 27-1/2"	Polished	1 Pack

2-3/8" stainless steel polished post, adjusts from 21-1/2" to 27-1/2".  
 Works with any 2-3/8" Stowable table mount (sold separately).  
 Works with any Thread-Lock™ table base (sold separately).



## THREAD-LOCK™ TABLE BASES

RETAIL IMAGE	PART NUMBER	LOCKING OR NON-LOCKING	FINISH	PACK QUAANTITY
A.	1690001-AL1	Locking	Anodized	6 Pack
B.	1690001-SL	Locking	Satin	6 Pack

OEM IMAGE	PART NUMBER	LOCKING OR NON-LOCKING	FINISH	PACK QUAANTITY
A.	3690001-AL	Locking	Anodized	20 Pack
B.	3690001-SL	Locking	Satin	20 Pack
C.	3690001-BLKL	Locking	Black Krinkle	20 Pack
D.	3690001	Non-Locking	Black Plastic	20 Pack

2-3/8" Threaded table base. High-strength aluminum, available in 3 finishes: Anodized, Satin or Black. 7" diameter with 5-3/4" hole pattern. Works with any 2-3/8" Thread-Lock™ table post (sold separately).



## STOWABLE PEDESTALS SETS

RETAIL IMAGE	PART NUMBER	DIAMETER	FINISH	LOCKING	PACK QUAANTITY
A.	1660012	2-3/8"	Polished	Non-Locking	1 Pack
B.	1660029	2-3/8"	Anodized	Non-Locking	1 Pack
C.	1660029-L	2-3/8"	Anodized	Locking	1 Pack

Package includes:

- 2-3/8" diameter aluminum post
- High-strength aluminum table mount
- 7" aluminum surface mount floor base with 5-3/4" hole pattern

Requires a 3-1/2" hole in deck.

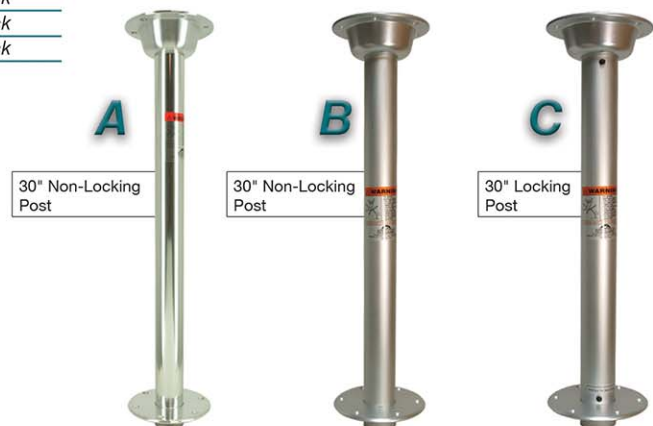

# Tables & Grills

## STOWABLE TABLE MOUNTS

RETAIL				
IMAGE	PART NUMBER	FINISH	DIAMETER	PACK QANTITY
A.	1660018	Anodized	2-3/8"	1 Pack

OEM				
IMAGE	PART NUMBER	FINISH	DIAMETER	PACK QANTITY
A.	3660018	Anodized	2-3/8"	20 Bulk
B.	3660023	Polished	2-3/8"	20 Bulk

Locking groove table mount. High-strength aluminum. Choice of two finishes: Anodized or Polished. 7" diameter mount with 5-3/4" hole mounting pattern. Works with any tapered 2-3/8" Thread-Lock™ post or any 2-3/8" Stowable table post (sold separately). 2-3/8" Tapered to 2-1/4"

Permanent Mold



Anodized



Polished

## ECONOMY STOWABLE TABLE MOUNTS

RETAIL				
IMAGE	PART NUMBER	FINISH	DIAMETER	PACK QANTITY
A.	1660004	Kennedy Gray	2-3/8"	1 Pack

OEM				
IMAGE	PART NUMBER	FINISH	DIAMETER	PACK QANTITY
A.	3660004	Kennedy Gray	2-3/8"	20 Bulk
B.	3660004-SM	Silver Metallic	2-3/8"	20 Bulk

Non-locking 2-3/8" table mount. High-strength aluminum. Choice of two finishes: Kennedy or Silver Metallic. 6.22" diameter with 5" hole pattern. Works with any 2-3/8" Stowable table post (sold separately). 2-3/8" Tapered to 2-1/4"

Die Cast



Kennedy Gray



Silver Metallic

## LOCKING STOWABLE TABLE POSTS

OEM				
IMAGE	PART NUMBER	FIXED HEIGHT	FINISH	PACK QANTITY
A.	3660525	25"	Anodized	20 Bulk
B.	3660527	27"	Anodized	20 Bulk

2-3/8" post locks into place to prevent accidental removal. Available in a wide selection of heights, with anodized finish. Works with any 2-3/8" Stowable table mount (sold separately). Works with any 2-3/8" Stowable table base (sold separately). 2-3/8" Tapered to 2-1/4"



25" Post



27" Post



## STOWABLE TABLE POSTS

RETAIL IMAGE	PART NUMBER	FIXED HEIGHT	FINISH	PACK QUANTITY
A.	1660032-A	27"	Anodized	6 Pack
A.	1660030-A	28"	Anodized	6 Pack

OEM IMAGE	PART NUMBER	FIXED HEIGHT	FINISH	PACK QUANTITY
A.	3660026-A	25"	Anodized	20 Bulk
B.	3660026-P	25"	Polished	20 Bulk
A.	3660032-A	27"	Anodized	20 Bulk
B.	3660032-P	27"	Polished	20 Bulk
A.	3660030-A	28"	Anodized	20 Bulk
A.	3660037-A	29"	Anodized	20 Bulk
A.	3660024-A	30"	Anodized	20 Bulk

2-3/8" post available in a wide variety of heights.  
 Anodized or polished aluminum finish.  
 Works with any 2-3/8" Stowable table mount (sold separately).  
 Works with any 2-3/8" Stowable table base (sold separately).  
 2-3/8" Tapered to 2-1/4"



Anodized

Polished

## ECONOMY STOWABLE POSTS

OEM IMAGE	PART NUMBER	FIXED HEIGHT	FINISH	PACK QUANTITY
A.	3660324	24"	Anodized	20 Bulk
B.	3660325	25"	Anodized	20 Bulk
C.	3660327	27"	Anodized	20 Bulk
D.	3660328	28"	Anodized	20 Bulk
E.	3660334	34"	Anodized	20 Bulk

2-3/8" post with anodized finish.  
 Works with any 2-3/8" Stowable table mount (sold separately).  
 Works with any 2-3/8" Stowable table base (sold separately).  
 2-3/8" Tapered to 2-1/4"

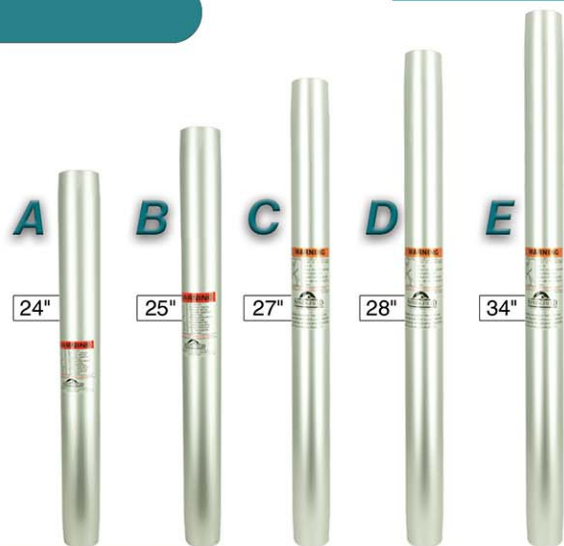

## STOWABLE TABLE BASES

RETAIL IMAGE	PART NUMBER	LOCKING	FINISH	PACK QUANTITY
A.	1660001	Locking	Polished	1 Pack
B.	1660003	Non-Locking	Kennedy	1 Pack
C.	1660017	Locking	Anodized	1 Pack

OEM IMAGE	PART NUMBER	LOCKING	FINISH	PACK QUANTITY
A.	3660002	Locking	Polished	20 Bulk
B.	3660003	Non-Locking	Kennedy	20 Bulk
C.	3660017	Locking	Anodized	20 Bulk
D.	3660017-BLK	Non-Locking	Black Krinkle	20 Bulk
E.	3660619	Non-Locking	Ice White	20 Bulk

High-strength aluminum, with choice of four finishes: Anodized, Polished, Kennedy Gray, or Black Krinkle. 7" diameter, with 5-3/4" hole mounting pattern. Available as locking or non-locking.  
 Works with any 2-3/8" Stowable table post (sold separately).  
 2-3/8" Tapered to 2-1/4"  
 Requires a 3.5" Hole into the deck.

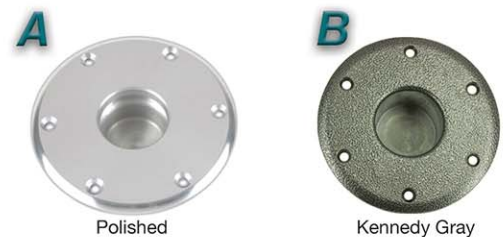

Polished

Kennedy Gray



Anodized

Black Krinkle

Ice White

PN: 3660619 Inspection Plate With Molded Table Mount

# Tables & Grills

## UNI-LOCK PEDESTAL SET

RETAIL			
IMAGE	PART NUMBER	LOCKING	PACK QUANTITY
A.	1660701	Locking Uni-Lock Pedestal Package	1 Pack
B.	1660702	Non-Locking Uni-Lock Pedestal Package	1 Pack

(A.) Package includes:

- 2-3/8" diameter locking anodized aluminum post
- High-strength black plastic table mount & floor base

(B.) Package includes:

- 2-3/8" diameter non-locking anodized aluminum post
- High-strength black plastic table mount & floor base

7" floor base with 5-3/4" mounting hole pattern.  
Requires a 3-1/2" hole in deck.



Locking Post

Non-Locking Post

## UNI-LOCK TABLE MOUNT

RETAIL			
IMAGE	PART NUMBER	DESCRIPTION	PACK QUANTITY
A.	1660704-L	Black Plastic Uni-Lock Table Mount	6 Pack

OEM			
IMAGE	PART NUMBER	DESCRIPTION	PACK QUANTITY
A.	3660704-L	Black Plastic Uni-Lock Table Mount	20 Pack

2-3/8" table mount, made from high-strength black plastic.  
7" diameter with 5-3/4" hole pattern.  
Works with any 2-3/8" Uni-Lock table post (sold separately).



## UNI-LOCK TABLE POSTS

OEM				
IMAGE	PART NUMBER	FIXED HEIGHT	LOCKS	PACK QUANTITY
A.	3660727	27"	Non-Locking	20 Pack

2-3/8" post with anodized finish.  
Available as locking or non-locking.  
Use with Uni-Lock table mount #3660704-L and  
Uni-Lock table base #3660703 (sold separately).



## UNI-LOCK TABLE BASE

RETAIL			
IMAGE	PART NUMBER	DESCRIPTION	PACK QUANTITY
A.	1660703	Black Plastic Uni-Lock Table Base	1 Pack

OEM			
IMAGE	PART NUMBER	DESCRIPTION	PACK QUANTITY
A.	3660703	Black Plastic Uni-Lock Table Base	20 Bulk

2-3/8" table base, high-strength  
black plastic. 7" diameter with 5-3/4"  
hole pattern. Works with any 2-3/8"  
Uni-Lock table post (sold separately).



## 2-7/8" TABLE PACKAGE

RETAIL			
IMAGE	PART NUMBER	DESCRIPTION	PACK QUANTITY
A.	1661127-CAL	2-7/8" Table Package - Anodized Fluted	1 Pack
B.	1661624	2-7/8" Surface Mount Package 24"- Anodized	1 Pack
N/A	1661624-P	2-7/8" Surface Mount Package 24"- Polished	1 Pack

(A.) Package includes:

- 2-7/8" diameter aluminum post - Anodized Fluted
- High-strength anodized aluminum table mount
- Anodized aluminum thru-deck floor base

9" floor base with 8" mounting hole pattern.  
Requires a 3-1/2" hole in deck.



## 2-7/8" STOWABLE TABLE MOUNT

OEM			
IMAGE	PART NUMBER	DESCRIPTION	PACK QUANTITY
A.	3660207	2-7/8" Stowable Table Mount - Anodized	20 Pack
B.	3100021-1	2-7/8" Non-Locking Swivel	20 Pack

2-7/8" high-strength anodized aluminum table mount.  
9" diameter with 8" mounting hole pattern.  
Works with any 2-7/8" stowable table post (sold separately).

Use [3100021-1](#) with [3664275-RV](#).



## 2-7/8" STOWABLE TABLE POSTS

OEM				
IMAGE	PART NUMBER	FIXED HEIGHT	FINISH	PACK QUANTITY
A.	3664230-RV	23"	Polished	10 Pack
A.	3664250-RV	25"	Polished	10 Pack
B.	3660127-CAL	27"	Anodized	20 Pack
C.	3660127-CPL	27"	Polished	20 Pack
A.	3664275-RV	27-1/2"	Polished	10 Pack
A.	3664300-RV	29-1/2"	Polished	

2-7/8" high-strength aluminum post with fluted anodized or polished finish, available in a variety of heights.

(A.)  
Use with 2-7/8" Trac-Lock™ swivel and 2-7/8" stowable base mount (sold separately)  
No Taper.

(B. & C.)  
Use with 2-7/8" Stowable table mount and base mount (sold separately)  
2-3/8" Tapered to 2-11/16"

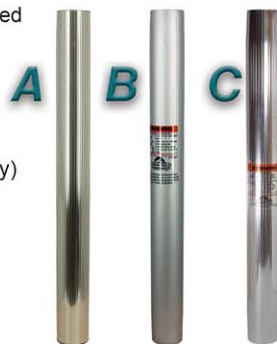

## 2-7/8" STOWABLE TABLE BASE

OEM				
IMAGE	PART NUMBER	DIAMETER	FINISH	PACK QUANTITY
A.	3660107	2-7/8"	Anodized	20 Pack

2-7/8" high-strength anodized aluminum table base. 9" diameter with 8" mounting hole pattern. Works with any 2-7/8" stowable table post (sold separately).

Requires a 3-1/2" hole in deck.



# Tables & Grills

## BOLT-LOCK PEDESTAL SET

RETAIL			
IMAGE	PART NUMBER	DESCRIPTION	PACK QUANTITY
A.	1662127	2-3/8" Bolt Lock Table Package	1 Pack

(A.) Package includes:

- 2-3/8" high-strength aluminum post - Anodized Finish
- High-strength black plastic table mount
- Aluminum floor base - Satin Finish

7" round surface mount floor base with 5-3/4" mounting hole pattern.



Attach post to base and twist for a secure, locking fit.



## BOLT-LOCK TABLE POST

OEM				
IMAGE	PART NUMBER	FIXED HEIGHT	FINISH	PACK QUANTITY
A.	3662027	27"	Anodized	20 Bulk
B.	3662027-P	27"	Brite Dip	20 Bulk
C.	3663027	27"	Anodized	20 Bulk
A.	3662030	30"	Anodized	20 Bulk
A.	3662031	31"	Anodized	20 Bulk
C.	3663030	31"	Anodized	20 Bulk

2-3/8" high-strength aluminum post with anodized or brite dip finish.

Use with any 2-3/8" Uni-Lock table mount and Bolt-Lock table base (sold separately).

(C.) Tapered post.  
(Use stowable table mount 2-3/8" Tapered.)

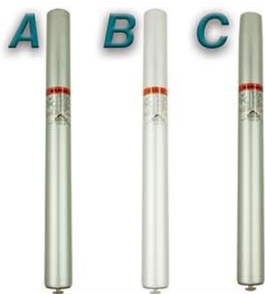

## BOLT-LOCK TABLE BASES

OEM				
IMAGE	PART NUMBER	FIXED HEIGHT	FINISH	PACK QUANTITY
A.	3690007	2-3/8"	Satin	20 Bulk
B.	3690007-A	2-3/8"	Anodized	20 Bulk
C.	3690007-P	2-3/8"	Polished	20 Bulk
C.	3690007-SS	2-3/8"	Stainless Steel	20 Bulk

Attach post to base and twist for a secure, locking fit.  
7" round floor base, with 5-3/4" hole pattern.



## TABLE ACCESSORIES

RETAIL			
IMAGE	PART NUMBER	DESCRIPTION	PACK QUANTITY
A.	2100025	Stowable Post Clips	6 Pack
B.	2100092	Thread-Lock™ Base Socket Cover	6 Pack
C.	2100093	Stowable Base Socket Cover	6 Pack
D.	7100170	Umbrella Socket Cover	1 Pack

OEM			
IMAGE	PART NUMBER	DESCRIPTION	PACK QUANTITY
B.	2100092-B	Thread-Lock™ Base Socket Cover	20 Bulk
C.	2100093-B	Stowable Base Socket Cover	20 Bulk
A.	2100104	Stowable Post Clips	50 Bulk
E.	2100115	Base Latch Kit	6 Bulk

Conveniently stow your 2-3/8" table pedestals when not in use (sold in pairs, as shown)

Plastic Thread-Lock™ cover keeps sockets clear when not in use



Plastic Stowable cover keeps sockets clear when not in use

Umbrella Socket Cover - Black

Replacement latch kit for Thread-Lock™ table bases



## ABOUT ACCESSORIES

Springfield Marine is best known for some of the highest quality seating hardware in the business, we also become well known as a supplier of fantastic boat and trailer accessories made to protect and extend the life of your boat's components and to enhance your boating fun and safety.

From practical boat mounted items such as fishing rod holders to fine recreational products like ski tow pylons, we offer a wide variety of boat accessories.

Our trailer accessories follow close behind... Practical and easy to use products from portable trailer jacks to a wide range of fully adjustable motor supports, we provide safety and functionality to make life easier at a time when you should be relaxing.

So explore the accessories that Springfield Marine has to offer and then go out and enjoy!

SKI TOWS • FOOTRESTS • ARMRESTS • GUARDIAN MOTOR SUPPORTS • FUEL COVERS



 [www.springfieldgrp.com](http://www.springfieldgrp.com) 

# Accessories

## SPRING-LOADED MOUNTING HINGES

OEM IMAGE	PART NUMBER	DESCRIPTION	PACK QUANTITY
A.	1080040	Spring Loaded Mounting hinge, 316 stainless steel	10 Pack

This space saving design offers more room on your boat without the sacrifice of comfort or support. Easily mounts to boat for quick installation. 316 polished stainless steel.

- Folds down easily
- Stows in up position
- Sold in pairs - Left & Right
- Available in 304 stainless steel & powder coated carbon steel



## FOLD DOWN MOUNTING HINGE

OEM IMAGE	PART NUMBER	DESCRIPTION	PACK QUANTITY
A.	1080031	Fold down mounting hinge	10 Pack
B.	1080032	Fold down Mounting Hinge	10 Pack
C.	1080034	Fold down 3-Piece Hinge	5 Pack

Another space saving design offers room on your boat without the sacrifice of comfort or support. Easily mounts to boat for quick installation.

- Folds down easily
- Stows in down position
- Sold in pairs - Left & Right
- Made from stainless steel



Patent Pending

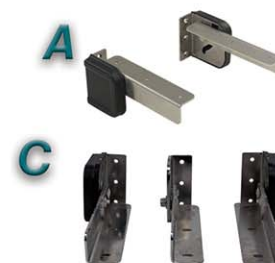

## ARMRESTS WITH HINGE

OEM IMAGE	PART NUMBER	DESCRIPTION	PACK QUANTITY
A.	1080040	White Armrest, No cushions	1 Pack

Armrests flip up yet offer a solid feel. Locking hinge allows backrest to fold completely parallel or in 3 lock-in tilt angles. Sold in pairs - Left & Right.



## ARMREST SUPPORTS

OEM IMAGE	PART NUMBER	DESCRIPTION	PACK QUANTITY
A.	1080009-M	Anodized Armrest Supports	1 Pack
B.	1080016-BL	Black Armrest with 101° bend	1 Pack

Sold in pairs - Left & Right.

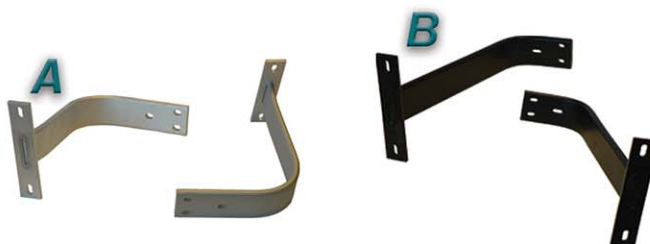

## PINCHLESS HINGES

OEM IMAGE	PART NUMBER	FINISH	DEPTH x HEIGHT	ANGLE	DESCRIPTION	PACK QUANTITY
A.	1080035	Mill	6" x 10"	115°	Economy	10 Bulk
A.	1080035-BLK	Black	6" x 10"	115°	Economy	10 Bulk
B.	1080025	Mill	6" x 9.5"	112°	Small Pinchless	10 Bulk
B.	1080025-BLK	Black	6" x 9.5"	112°	Small Pinchless	10 Bulk
B.	1080027	Mill	6" x 10.5"	112°	Medium Pinchless	10 Bulk
B.	1080027-BLK	Black	6" x 10.5"	112°	Medium Pinchless	10 Bulk
B.	1080026	Mill	6" x 12.5"	112°	Large Pinchless	10 Bulk
B.	1080026-BL	Black	6" x 12.5"	112°	Large Pinchless	10 Bulk
C.	1080025-SS	Polished	6" x 9.5"	118°	Stainless Steel Pinchless	10 Bulk
D.	1080028-BR	Brown	7.75" x 11.12"	102°	Large Pinchless	10 Bulk
D.	1080028-BLK	Black	7.75" x 11.12"	102°	Large Pinchless	10 Bulk

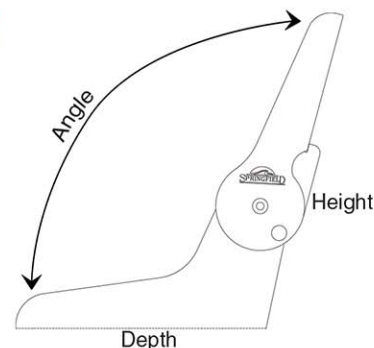

High-strength aluminum. Sold in pairs - Left & Right.



Economy

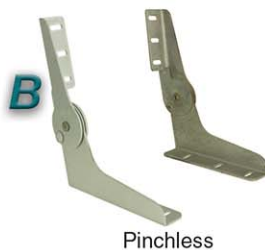

Pinchless



Stainless Steel Pinchless

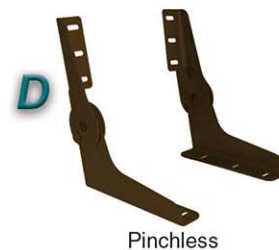

Pinchless

## PARALLEL SEAT HINGE

OEM IMAGE	PART NUMBER	DESCRIPTION	PACK QUANTITY
A.	3042045	Parallel Seat Hinge	10 Pack
A.	3042048	Parallel Seat Hinge	10 Pack
B.	3042045-SS	Parallel Seat Hinge - Stainless Steel	10 Pack

The Polished Aluminum parallel seat hinges are designed to move the seat's backrest forward and back, and offers secure and stable support in either positions. Sold in pairs as shown.



## BOLSTER SEAT HINGE

OEM IMAGE	PART NUMBER	DESCRIPTION	PACK QUANTITY
A.	1042515	Bolster Flip up Hinge	10 Pack
A.	1042501-BD1	Parallel Bolster Seat Hinge	10 Pack

Bolster Seat Hinge converts your seat from a sit-down to a stand-up. Quilts built, Brite Dip Aluminum offers durable long lasting satisfaction.

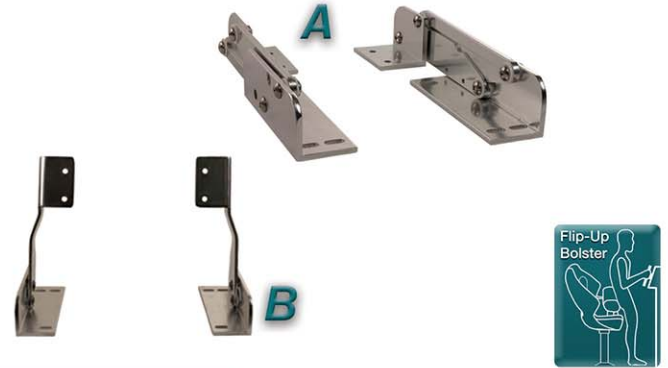

## REMOVABLE BACKREST

OEM IMAGE	PART NUMBER	DESCRIPTION	PACK QUANTITY
A.	1080013-G	One Piece Chair Armrest	1 Pack

Sturdy polished aluminum with plastic armrest. One Piece construction provides added strength.



## REMOVABLE BACKREST

OEM IMAGE	PART NUMBER	DESCRIPTION	PACK QUANTITY
A.	3760060	Backrest Base - 4.5" x 2"	20 Pack
B.	3760060-ND	No-Drain Base, 4.5" x 2"	20 Pack
B.	3760063-ST	Straight Removable Backrest 14-5/8"	10 Pack

Constructed from high-strength aluminum with a fine satin brite dip finish. Plastic nylon inserts to provide a secure, snug fit. Drain tube allows water to escape from the base. Ball detent for secure contact and unintentional detachment. Requires 6-1/2" bellow deck.

Custom lengths available upon request

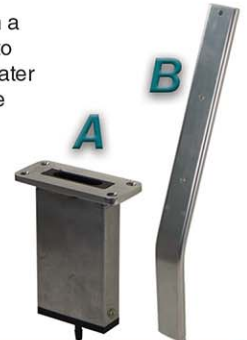

## SLIDE-OUT FOOTREST

RETAIL IMAGE	PART NUMBER	DESCRIPTION	SIZE	PACK QUANTITY
A.	1580074	Round Pedestal Mount	4"	1 Retail

Large 20" x 7" platform slides 8" in and out. Easy height adjustment. Polyboard platform with grooves. Aluminum mounting collar with black krinkle finish and a plastic bushing to fit 4" diameter pedestals.

Bushings available to fit 2-7/8" & 3-1/2" posts (sold separately).

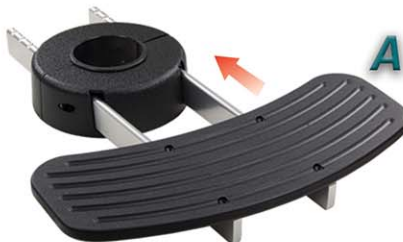

## DROP-DOWN FOOTREST

RETAIL IMAGE	PART NUMBER	DESCRIPTION	PACK QUANTITY
A.	1580030	Drop down - 8-1/2" x 13-1/2" Platform	1 Retail

Easily mounts to bottom of chair for quick installation. (hardware not included). Made from polished high-strength aluminum.

Footrest flips-up for out-of-the-way storage.

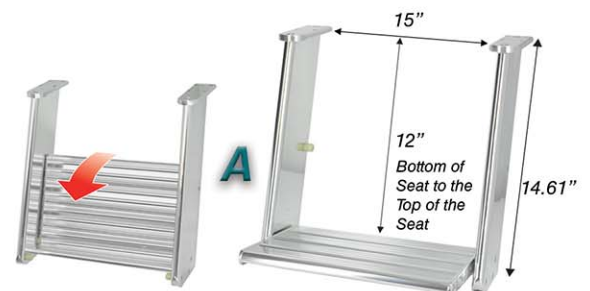

# Accessories

## FOOTREST & BUSHING SET

IMAGE	A.	B.	C.	RETAIL
SIZE	BLACK	CAST	GRAY	PACK QUANTITY
2-7/8"	-	1580014	-	1 Retail
2-7/8"	1580017-BLK	1580017	1580017-G	1 Retail
3-1/2"	1580021-BLK	-	-	1 Retail
4"	1580022-BLK	-	1580022	1 Retail

Footrest easily mounts to several sized pedestals. Split design allows mounting without removing seat. Internal plastic bushing prevents scratching of pedestal. (PN: 1580014 is equipped with a thin bushing)



### Replacement Bushings

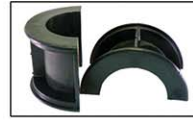

One Pack Only	
Size	Part Number
2-3/8"	2171044
2-7/8"	2171041
3-1/2"	2171042
4"	2171040

### Replacement Collar Fits All Bushings Listed Above



One Pack Only	
Part Number	
2170095-BLK	



## HELMSMAN FOOTREST

RETAIL	IMAGE	PART NUMBER	DESCRIPTION	SIZE	PACK QUANTITY
	A.	1580040	11" x 16" Platform	4"	1 Retail
	B.	1580045	Folding Platform	4"	1 Retail
	C.	1580048	Chair Mounted Footrest	4"	1 Retail

(A. & B.) High-strength cast aluminum with black powder coat finish. Cast-in anti-slip grooves. Extends 20" out from center of post. Fits 4" post. Bushings available to fit 2-7/8" and 3-1/2" posts (sold separately).

(C.) High-strength cast aluminum with black powder coat finish. Cast-in anti-slip grooves. Footrest mounts to bottom of seat.

B. & C.  
Platform pivots up  
for out-of-the-way  
storage



## STAINLESS STEEL & ALUMINUM FOOTRESTS

RETAIL	IMAGE	PART NUMBER	DESCRIPTION	FINISH	BUSHING	PACK QUANTITY
	A.	1580080-AL	28" Full Round Footrest	Aluminum	4"	1 Pack
	A.	1580095-AL	28" Half Round Footrest	Aluminum	4"	1 Pack
	A.	1580080-SS	28" Full Round Footrest	Stainless Steel	4"	1 Pack
	A.	1580095-SS	Half Round Footrest	Stainless Steel	4"	1 Pack
	B.	1580087-SS	14" Full Round Footrest	Stainless Steel	2-7/8"	1 Pack
	B.	1580087-AL	14" Full Round Footrest	Aluminum	2-7/8"	1 Pack
	C.	1580082-SS	14" Full Round Footrest	Stainless Steel	2-3/8"	1 Pack
	C.	1580082-AL	14" Full Round Footrest	Aluminum	2-3/8"	1 Pack

A: 28" round 2-piece footrest, available as 316 electro polished stainless steel or anodized polished aluminum. Accepts bushings to fit 4", 3-1/2", & 2-7/8" posts. 1" round rail with 1/8" thick vertical spokes.

B: 14" Round 2-piece footrest, available as 316 electro polished stainless steel or anodized polished aluminum. Accepts bushings to fit 2-7/8" & 2-3/8" posts. 1" round rail with 1/8" thick vertical spokes.

C: Half round footrest with mounting collar, available as 316 electro polished stainless steel or anodized polished aluminum. Accepts bushings to fit 4", 3-1/2", & 2-7/8" posts. 1" round rail with 1/8" thick vertical spokes.





## 5 LEGGED DECK BASE

## FOLDING LEG

RETAIL IMAGE	PART NUMBER	DESCRIPTION	PACK QUANTITY
A.	1580550-BLK	5 Legged Deck Base	1 Pack
B.	2100332	Floor Pod	5 Pack
C.	2100340	Locking 75MM Caster	5 Pack

32" diameter 5 legged deck base with mounting plate. Mounting plate is pre drilled with 5/16 x 18 tap to accept any Springfield Marine 12" or 9" round pedestal base.

Approximately 4" high with floor pods or 6" high with casters. (A.) Does not come with casters / pods.



Floor Pod



Locking Caster

RETAIL HEIGHT	STAINLESS STEEL	ALUMINUM	BULK QUANTITY
11-1/2"	1081115-SS	1081115	10 Bulk
13"	1081135-SS	1081135	10 Bulk

Rubber stopper to prevent scratching of surfaces. Available in 304 Stainless Steel & Brite Dip Aluminum

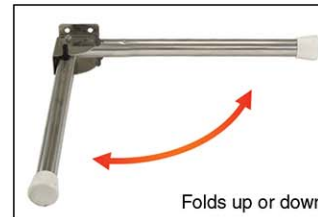

Folds up or down



## DECK PLATES AND RINGS

RETAIL IMAGE	PART NUMBER	DESCRIPTION	DIAMETER	HOLE PATTERN	PACK QUANTITY
A.	1580004	Split Under Deck Ring	9"	8"	1 Pack
B.	1580005	Aluminum Deck Plate	12"	11"	1 Pack
B.	1580005-SS	Stainless Steel Deck Plate	12"	11"	1 Pack
C.	1580006	Aluminum Deck Plate	9"	8"	1 Pack
D.	1580007	Aluminum Deck Ring	9"	8"	1 Pack

OEM IMAGE	PART NUMBER	DESCRIPTION	DIAMETER	HOLE PATTERN	PACK QUANTITY
A.	3580004	Split Under Deck Ring	9"	8"	10 Bulk
B.	3580005	Aluminum Deck Plate	12"	11"	10 Bulk
C.	3580006	Aluminum Deck Plate	9"	8"	10 Bulk
D.	3580007	Aluminum Deck Ring	9"	8"	10 Bulk
E.	3580012-A	Anodized Deck Plate	12"	8"	10 Bulk
E.	3580012-P	Anodized Deck Plate	12"	8"	10 Bulk



Split Deck Ring



9" Deck Plate



9" Deck Ring



12" Deck Plate



12" Correction Plate

Made from non-removable pedestals. 9" deck plates have 8" hole pattern. 12" deck plates have 11" hole pattern (unless noted).

## HANDLE ASSEMBLIES & TRAC-LOCK™ SERVICE PARTS

OEM IMAGE	PART NUMBER	DESCRIPTION	PACK QUANTITY
A.	2100030	2-Piece Power Pedestal Handle	6 Bulk
B.	2100034	2-3/8" U-Stem Handle Assembly	6 Bulk
C.	2171062	Removable Air-Ride Handle	6 Bulk
D.	2100095	Locking Handle for 2-7/8" Trac-Lock Seat Mount	6 Bulk
E.	2100099	Locking Handle for 2-7/8" Trac-Lock™ Seat Mount	6 Bulk
F.	2100096	Air-ride Replacement Handle	6 Bulk
G.	2100033	Handle for Quad Action Swivel	6 Bulk
H.	2171072	Tension Handle for Trac-Lock™ III	6 Bulk
I.	2171000	2-3/8" Trac-Lock™ II Swivel Bushing // Pre-2002	6 Bulk
J.	2171001	2-7/8" Trac-Lock™ II Swivel Bushing // Pre-2002	6 Bulk
K.	2170004	Slide Pads For Trac-Lock™ III	6 Bulk
L.	2171008	2-3/8" Trac-Lock™ III Swivel Bushing // 2002-Newer	6 Bulk
M.	2171009	2-7/8" Trac-Lock™ III Swivel Bushing // 2002-Newer	6 Bulk



Replacement handles and assemblies for air-ride pedestals, seat mounts, etc. Replacement and service parts for Trac-Lock™ seat mounts.

# Accessories

## STERN HANDLES

RETAIL IMAGE	PART NUMBER	DESCRIPTION	PACK QUANTITY
A.	1840054	Stern Handles With Pre Drilled Holes	6 Retail

OEM IMAGE	PART NUMBER	DESCRIPTION	PACK QUANTITY
A.	3840054	Stern Handles w/ Pre Drilled Holes	100 Bulk
B.	3840054-CS	Stern Handles w/ Counter Sunk Holes	100 Bulk
C.	3840054-NH	Stern Handles No Mounting Holes	100 Bulk

High-strength cast aluminum rugged construction. Extra smooth 6" grip. Distance between mounting holes: 6-5/8".

Sold in pairs

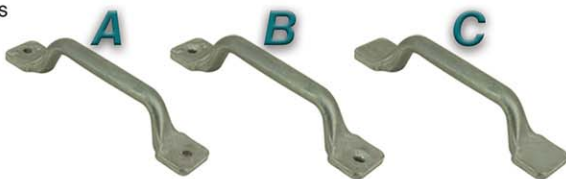

## WARNING LABELS

OEM IMAGE	PART NUMBER	DESCRIPTION	PACK QUANTITY
A.	8123050	Warning Label, Class "B"	500 Bulk
B.	8123052	Warning Label, Class "AD"	100 Bulk
C.	8123060	Warning Label, Ski Pylon	50 Bulk
D.	2100272-RTS	Arch Warning Label	250 Bulk

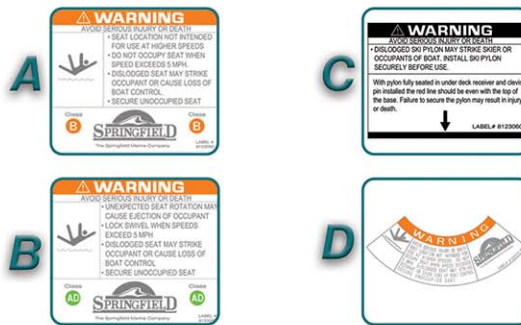

## BOAT CLEAT

OEM IMAGE	PART NUMBER	DESCRIPTION	PACK QUANTITY
A.	3820008	Aluminum Boat Cleat	50 Bulk

Made from heavy-duty extruded aluminum construction for maximum strength and durability.



## OARLOCK SOCKETS

RETAIL IMAGE	PART NUMBER	DESCRIPTION	BUSHING I.D.	PACK QUANTITY
A.	1840021	Oarlock Sockets, #20	9/16"	6 Pack

OEM IMAGE	PART NUMBER	DESCRIPTION	BUSHING I.D.	PACK QUANTITY
A.	3840020	Oarlock Sockets, #20	9/16"	100 Bulk
A.	3840021	Oarlock Sockets, #30	1/2"	100 Bulk

Round gunwale sockets with plastic inserts. Fits up to 9/16" oarlocks.



Sold in pairs as shown.

## Rod Holders

RETAIL IMAGE	PART NUMBER	DESCRIPTION	PACK QUANTITY
A.	1760004	Fishing Rod Holders	6 Pack

OEM IMAGE	PART NUMBER	DESCRIPTION	PACK QUANTITY
A.	3760004	Fishing Rod Holders	20 Bulk

Holds up to 3 rods. Mounting vertical or horizontal. ABS plastic with foam inserts.

Sold in pairs with bungee cords.



## Locking Shelf Hinge

RETAIL IMAGE	PART NUMBER	DESCRIPTION	PACK QUANTITY
A.	1080030	Stainless Steel Shelf Hinges	1 Pack

90° horizontal locking mechanism. Fold shelf down when not in use. Stainless Steel.

Sold in pairs as shown.



## INBOARD POP UP SKI TOWS

OEM IMAGE	PART NUMBER	DESCRIPTION	PACK QUANTITY
A.	1800090	Pop Up Ski Tow, Inboard, Round Base	1 Pack

Pop Up Ski Tows are designed with the strength to handle most tow sport activities. The single post design conceals neatly away into the deck when not in use and is activated with a single locking feature for easy conversion into ski ready position.

Pops up with just a twist, then is held up with a spring.

- 2-1/2" above deck, and 5-1/4" below deck
- Made from high strength aircraft aluminum
- Anodized finish
- Designed for 2000 lbs static load



Stows flush

## OUTBOARD POP UP SKI TOWS

OEM IMAGE	PART NUMBER	DESCRIPTION	ABOVE DECK	BELOW DECK	PACK QUANTITY
A.	1800095	Pop Up Ski Tow, Outboard, Round Base	22"	37"	1 Pack
A.	1800095-EX	Pop Up Ski Tow, Outboard, Round Base	22"	45"	1 Pack
B.	1800096	Pop Up Ski Tow, Outboard, Oval Base	22"	37"	1 Pack
C.	1800096-E	Electric Ski Tow, Outboard, Oval Base	23"	37.5"	1 Pack
B.	1800097	Pop up Ski Tow, Outboard, Oval Base	15"	28"	1 Pack

Ski Tows are designed with the strength to handle most tow sport activities. The single post design conceals neatly away into the deck when not in use.

- Stows flush with deck
- Made from aircraft grade aluminum
- Designed for 2000 lbs static load // Except for PN: 1800096-E

(A. & B.) The Pop Up Ski Tows are activated with a single locking feature for easy conversion into ski ready position. 22" above deck and 37" below deck.

(C.) The Electric Ski Tow tracks up and down on a guid rail, and raises in under 25 seconds, at the press of a switch. 23" above deck and 37.5" below deck. Designed for 1600lbs of Static Load.



Pop Up Ski Tow - Round Base



Pop Up Ski Tow - Oval Base



Electric Ski Tow - Oval Base

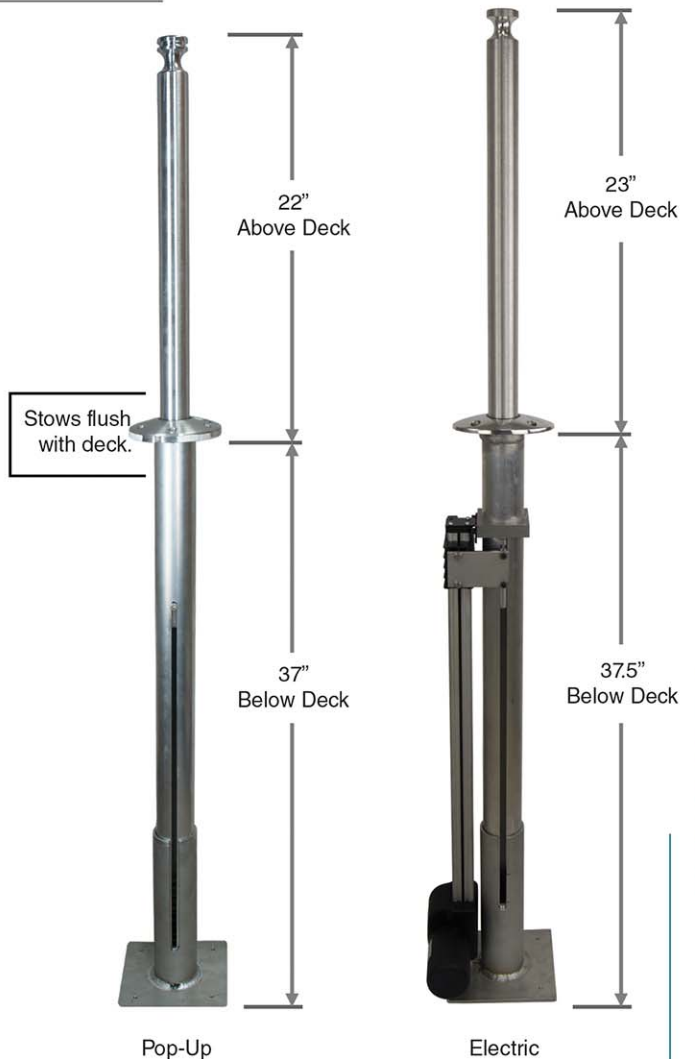

## SKI TOW PYLONS

OEM IMAGE	PART NUMBER	DESCRIPTION	TOTAL LENGTH	ABOVE DECK	PACK QUANTITY
A.	1800039-T	Ski-Tow, Twist In	57.7"	40"	1 Pack
A.	1800040-T	Low Profile Twist In	38.7"	33.3"	1 Pack
A.	1800041-T	Ski-Tow, Twist In	54.7"	37"	1 Pack
A.	1800043-T	Low Profile Twist In	45.7"	28"	1 Pack
B.	1800051-T	Ski-Tow, Twist In	49.7"	32"	1 Pack
C.	1800061-T	Ski-Tow, Twist In	60.7"	43"	1 Pack
C.	1800066-T	Ski-Tow, Twist In	64.7"	38"	1 Pack
C.	1800067-T	Ski-Tow, Twist In	66.7"	37"	1 Pack

1-3/4" high-strength aircraft aluminum pylons.  
Available in a variety of lengths.  
Must have a minimum of 19" below deck.

For strength purposes 43" is the most unsupported distance allowed.

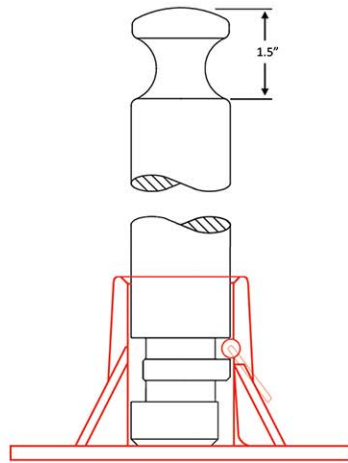

Notched in two points allowing easy drop-in and removal without accessing below the deck.

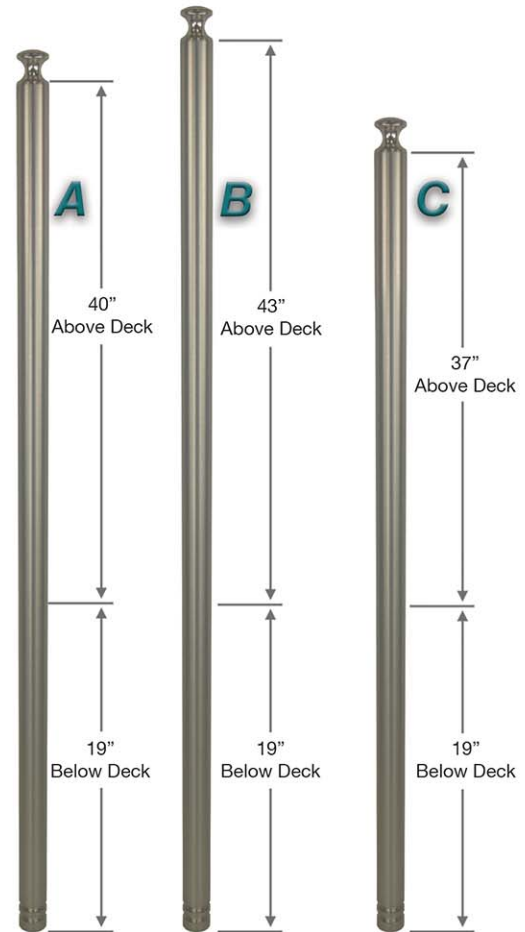

## MOUNTING RECEIVER & BASES

OEM IMAGE	PART NUMBER	DESCRIPTION	PACK QUANTITY
N/A	1640034	4-1/2" x 4-1/2" Deck Base	1 Bulk
N/A	1640036	7" x 7" Ski Tow Deck Base	1 Bulk
A.	1800044	Ski Tow Receiver	1 Bulk
B.	1800044-SS	Heavy Duty Low Profile Receiver	1 Bulk
C.	1800047	Bracket Strap for Pop-Up Ski Tow	1 Bulk
D.	1800048	Mounting Plate w/ Hardware 9.75"	5 Pack
E.	3640032-PP	3-1/2" x 5-1/2" Deck Base	20 Bulk
F.	3640034	4-1/2" x 4-1/2" Deck Base	20 Bulk
G.	3640035	2-Hole Ski Tow Deck Base, Mill	10 Bulk
G.	3640035-S	2-Hole Ski Tow Deck Base, Satin	10 Bulk
H.	3640036	7" x 7" Ski Tow Deck Base	20 Bulk
N/A	3640038	Ski Tow Deck Base Oversize 8.5"	20 Bulk
I.	3640040	7" x 7" Low Profile Ski Tow Deck Base	20 Bulk
N/A	3640045-S	7" x 7" Ski Tow/Spring-Lock™ Deck Base w/ KingPin™	10 Bulk
N/A	3640047-S	7" x 7" Ski Tow/Plug-In™ Deck Base	10 Bulk
D.	1800052	Mounting Plate 5.75"	5 Bulk



Necessary items for mounting ski tow pylons to your boat.

# Accessories

## FUEL SEPARATOR COVERS

OEM IMAGE	PART NUMBER	DESCRIPTION	PACK QUANTITY
A.	3760022	Large - Narrow Fuel Separator Cover	10 Bulk
B.	3760025	Small Fuel Separator Cover	10 Bulk
C.	3760027	Small - Narrow Fuel Separator Cover	10 Bulk

- Made from high-strength injection molded polypropylene
- Fitted ribs allow quick snap fit and easy access to fuel filter
- Protects from damage due to impact and sun
- Used for shielding to protect against accidental contact by a tool or the battery terminals during servicing, installation, or removal
- ABYC E-10.7.8 - Each metallic fuel line and fuel system component within 12 inches of the horizontal or vertical plane of the battery surface containing the terminals, as installed, shall be shielded with dielectric material to protect against accidental short-circuiting

Designed for Yamaha:  
Above 115 HP

Designed for Yamaha:  
115 HP & Below

Designed for  
Mercury Verado



## TRANSOM TUFF'NER™

RETAIL IMAGE	PART NUMBER	DESCRIPTION	SIZE	PACK QUANTITY
A.	1780203	Heavy-Duty Tuff'ner™	4" x 17"	1 Pack
B.	1780223	Economy Tuff'ner™	2" x 15"	1 Pack

Adds strength and longevity to boats transom by evenly distributing forces during fast starts, high speed runs, and sharp turns. High-strength aluminum. Easy to install using two bolts (not included) 12-15/16" bolt pattern.



## QUICK CHANGE TRAILER JACK

RETAIL IMAGE	PART NUMBER	DESCRIPTION	PACK QUANTITY
A.	1840046	Trailer Jack, For Wheel Size 10" to 15"	1 Pack

- Makes elevating trailer quick, easy, and safe.  
High-strength aluminum construction.  
Fits round or square axles.
- Trailer Jack -- Lifts up to 2 tons

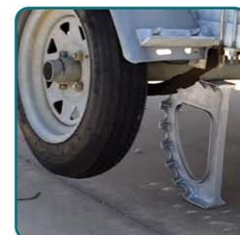

Trailer Jack / In Action

## GUARDIAN MOTOR SUPPORT

RETAIL			
IMAGE	PART NUMBER	DESCRIPTION	PACK QUANTITY
A.	1780238	Extended, Over The Roller	6 Retail
B.	1780240	Deluxe Combo, Over The Roller & Bolt-On	6 Retail
C.	1780242	Standard Combo, Over The Roller & Bolt-On	6 Retail
D.	1780245	Economy Combo, Over The Roller & Bolt-On	6 Retail

OEM			
IMAGE	PART NUMBER	DESCRIPTION	PACK QUANTITY
E.	1780230	V Mount, Bolt-On	10 Bulk
F.	1780233	Deluxe, Over The Roller 25" - 37"	10 Bulk
A.	3780238	Extended, Over The Roller 33" - 53"	10 Bulk
G.	3780245-01	Economy, Motor Support, No U-Brace 35.5" - 47"	10 Bulk
G.	3780245-02	Economy, Motor Support, No U-Brace 20.5"-33.75"	10 Bulk
D.	3780245-03	Economy, Over The Roller 22" - 34"	10 Bulk
D.	3780278	Economy, Motor Support 30.75" - 50.75"	10 Bulk

Cast aluminum head with high-strength aluminum shaft.  
 Supports the cantilevered weight of the motor.  
 Stabilizes engine and steering mechanism when trailering.  
 Varying adjustability. Includes 15" black EPDM rubber holding strap.

Available in Bolt-On or Over The Roller strap-on.

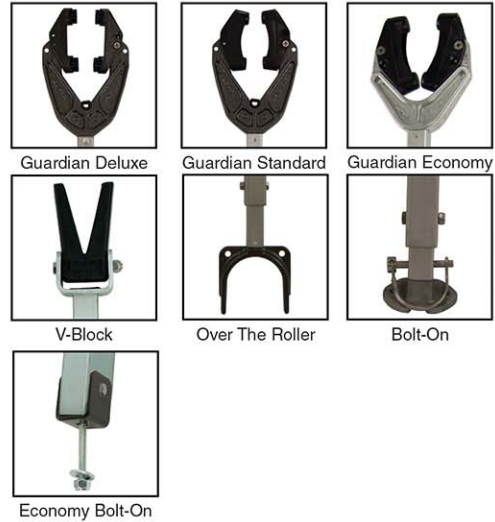

Adjusts  
33" to 53"



Adjusts  
25" to 37"



Adjusts  
20" to 31-1/2"



Adjusts  
22" to 34"



Fixed Height  
25"



Adjusts  
25" to 37"



No Trailer Mount

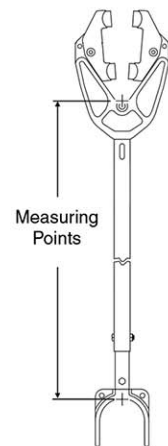

Over The Roller

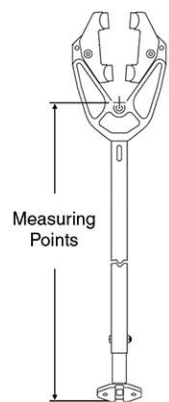

Bolt-On

# Accessories

## EXTEND-A-REACH MOTOR SUPPORT

RETAIL IMAGE	PART NUMBER	DESCRIPTION	PACK QUANTITY
A.	1780250	Extend-A-Reach Support Kit	1 Pack

OEM IMAGE	PART NUMBER	DESCRIPTION	PACK QUANTITY
B.	2100079	Extend-A-Reach Y Bushing	1 Pack



Extend-A-Reach secures the motor to trailer crossbar. Includes all parts necessary for easy installation. Removes easily for quick loading and unloading. Heavy-duty steel with Corrosion resistant e-coat finish. Includes 15" black EPDM rubber holding strap. Adjusts from 26" to 56".



## GUARDIAN REPLACEMENT PARTS

OEM IMAGE	PART NUMBER	DESCRIPTION	PACK QUANTITY
A.	2100067	T-Brace For Bolt-On	6 Bulk
B.	2100073	Bolt-On Clevis Pin	6 Bulk
C.	2100074	Support Bushing Kit	6 Bulk
D.	2100075	Plastic Swivels For Motor Support	6 Bulk

Replacement parts for Guardian Motor Supports.



Bolt-On T-Brace  
For Guardian Motor Supports



Bolt-On Clevis Pin  
(Secures T-Brace To Motor Support)

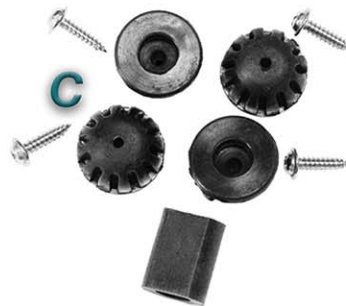

Replacement Bushing Kit For  
Guardian Motor Support



Replacement Plastic Swivels  
For Guardian Motor Support

# Part Number Index

PART NUMBER	PAGE	PART NUMBER	PAGE	PART NUMBER	PAGE
1000202	17	1040646	11	1043200-SFB	21
1000205-L	17	1040647	11	1043200-SFB1	21
1000605-L	18	1040649	11	1043224	21
1001003	13	1040651	12	1043224-B	21
1001204-L	18	1040653	12	1043224-CS	21
1001303	24	1040655	12	1043240-SFB	23
1001304	24	1040661	11	1043245-SFB	23
1001408-L	18	1040663	11	1043250-SF	20
1001414-L	17	1040665	11	1043250-SFB	20
1002062	29	1040667	11	1043250-SFB1	20
1002063	29	1040668	11	1043251	20
1002083	29	1040691	13	1043253	20
1002093	29	1040693	13	1043259	20
1002110	29	1040697	13	1043263	20
1003224	21	1040800	22	1043325	21
1020003	25	1040800-NB	22	1043334	21
1020009	25	1040809	25	1043501	22
1040002	25	1040820-01	22	1043691	20
1040009	25	1040820-02	22	1043693	20
1040211	15	1040825-01	22	1043699	20
1040212	15	1040825-02	22	1045014	16
1040212-NS	15	1040900	23	1045020	16
1040213	15	1040925-SFB	23	1045028	16
1040213-NS	15	1040930-01	23	1045035	16
1040214	15	1041419	6	1045036	16
1040215	15	1041483	6	1045070	26
1040216	15	1041519	6	1045075	26
1040216-NS	15	1041583	6	1060002-M	16
1040217	15	1041600-SF1	5	1060002-S	16
1040224	21	1041606-1	5	1060004	16
1040230-01	15	1041631-1	5	1060004-C	16
1040350-SL	15	1041634-1	5	1060100	17
1040351-SL	15	1041636	5	1060100-L	17
1040352-PIC	15	1041684-1	5	1060204	16
1040352-PIM	15	1041733	5	1060204-C	16
1040353-TLC	15	1041800-SF	6	1060206-M	16
1040353-TLM	15	1041900-SF	6	1060206-S	16
1040355-KPC	15	1042010	26	1060407	16
1040355-KPM	15	1042010-SF	26	1060407-C	16
1040357-KPC	15	1042039	13	1060410-M	16
1040357-KPM	15	1042046	19	1060410-S	16
1040407	22	1042047	19	1060605	16
1040513	10	1042050	19	1060605-C	16
1040543	10	1042064	28	1060610-M	16
1040621	12	1042066	28	1060610-S	16
1040622	12	1042080-B	27	1061014-S	16
1040623	12	1042080-W	27	1061014-SG	16
1040623-PDQ	12	1042081-BC	27	1061015-M	8
1040624	12	1042093	28	1061015-MB	8
1040625	12	1042110-B1	27	1061015-MS	8
1040626	12	1042120-XLB1	27	1061015-S	8
1040627	12	1042180-01	28	1061015-SB	8
1040628	12	1042185-01	28	1061015-SW	8
1040629	12	1042501-BD1	103	1061016	8
1040629-PDQ	12	1042515	103	1061017	8
1040643	11	1043001	19	1061018	8



**PART NUMBER PAGE**

1061017	8
1061018	8
1061019	8
1061020	8
1061021	8
1061025	8
1061057	7
1061063-B	7
1061069-B	7
1061072	7
1061077-1	7
1061079-1	7
1061100	13
1061100-C	9
1061100-S	9
1061103-C	9
1061104-C	9
1061104-S	9
1061105-C	9
1061105-S	9
1061106-C	9
1061107-C	9
1061108-C	9
1061112-C	9
1061113-C	9
1061114-C	9
1061115-C	9
1061121-C	9
1061123-C	9
1061201	16
1061201-C	16
1061205-M	16
1061205-S	16
1061301	24
1061302	24
1061311	24
1061403	16
1061405-M	16
1061405-S	16
1062025-01	10
1062031	11
1062034	11
1062583	10
1062683	10
1080009-M	102
1080013-G	6, 103
1080016-BL	102
1080018	25
1080021	14
1080021-DB	14
1080021-EMB	14
1080021-SS	14
1080022	14
1080025	102
1080025-BLK	102
1080025-SS	102

**PART NUMBER PAGE**

1080026	102
1080026-BLK	102
1080027	102
1080027-BLK	102
1080028-BL	102
1080028-BR	102
1080030	106
1080031	102
1080032	102
1080034	102
1080035	102
1080035-Blk	102
1080040	102
1080080	26
1080085	26
1080088	26
1080115	79
1080117	79
1080120	14
1080121	14
1080125-CR	14
1080136	73
1080136-L1	73
1081000-F	24
1081093	24
1081115-SS	105
1081135-SS	105
1081224-G	25
1081224-GAL	25
1081230-G	25
1081230-GAL	25
1081233	25
1099050-2	26
1099050-2A	26
1100007	86
1100007-PDQ	86
1100009	86
1100012	87
1100015	87
1100016	84
1100017	84
1100018	86
1100019	86
1100021-1	70
1100021-L1	50, 70
1100031-1	42, 47, 52, 64
1100031-L1	42, 47, 64
1100050	87
1100050-L	87
1100115	87
1100300	83
1100318	86
1100319	86
1100360	82
1100521-1	70
1100521-L1	70

**PART NUMBER PAGE**

1100531-1	64
1100531-L1	64
1100550-L	87
1100930-A1	71
1104010	87
1240006-DAL	72
1240006-MAL	72
1240006-MPL	72
1240007-MAL	72
1240008-MAL	72
1240008-MAL2	74
1240008-MALN	74
1240008-MSL	72
1240008-SAL	72
1240009-DAL	72
1240009-MAL	72
1240010-MAL	72
1240010-MAL2	74
1240010-MSL	72
1240011-MAL	72
1240012-DAL	72
1240012-MAL	72
1240012-SAL	72
1240014-DAL	72
1240014-MPL	72
1240015-SAL	72
1240018-DAL	72
1240020-DAL	72
1240024-DAL	72
1240206-MPL	72
1240609-L1	69
1240612-L1	69
1240615-L1	69
1240616	69
1240629	69
1240629-L	69
1240639	69
1240716-L	69
1240729-L	69
1240739-L	69
1240748-MLNS	67
1240749-LNS	67
1240749-MLNS	67
1240750-MLNS	67
1240752-MLNS	67
1250100	61
1250100-L	61
1250100-L1	61
1250150-L	61
1250150-L1	61
1250200-L	61
1250200-L1	61
1250206-L	61
1250250-L	61
1250250-L1	61
1250252-L	62

# Part Number Index

PART NUMBER	PAGE	PART NUMBER	PAGE	PART NUMBER	PAGE
1250253-L	62	1260018	69	1300715-L1	46
1250254-L	62	1260024	69	1300750-1	49
1250256-L	61	1260606-DAL	74	1300750-A1	49
1250256-LN	61	1260606-DSL	74	1300750-L1	49
1250300	67	1260607-MAL	74	1300750-R1	49
1250301	67	1260610-DAL	74	1300751-1	49
1250307-MLNS	65	1260610-DSL	74	1300754-1	49
1250308-MLNS	65	1260615-DAL	74	1300901	46
1250309	63	1270340-P	78	1300902	46
1250309-L	63	1270346-P	78	1301037	46
1250309-LNS	65	1270350-P	78	1301038	46
1250309-MLNS	65	1270350-W	78	1304012-HL	48
1250310-LNS	65	1270354-P	78	1304015-HL	48
1250310-MLNS	65	1270370-W	78	1312701	47
1250312	63	1270640-SS	78	1440010-DSL	65
1250312-L	63	1270646-SS	78	1440013-SAL	65
1250312-LNS	65	1270650-SS	78	1440213	63
1250312-MLNS	65	1271333-PE	76	1440213-L	63
1250313-L	63	1271334-PE	76	1440220	63
1250313-LNS	65	1271338-PEF1	68	1440220-L	63
1250313-MLNS	65	1271340-PE	76	1440228	63
1250314-LNS	65	1271349-PE	76	1440248	88
1250315	63	1271380-01	68	1440334	63
1250315-L	63	1271640-SSE	76	1440607-MAL	65
1250315-MLNS	65	1271649-SSE	76	1440609-MAL	65
1250321	67	1275580-NC	80	1440610-MAL	65
1250321-NS	67	1276548	79	1440612-MAL	65
1250326-NS	67	1280104-MAL	73	1440613-MAL	65
1250328-NS	67	1280104-MPL	73	1440615-MAL	65
1250351-MLNS	65	1280104-SAL	73	1450012-P	78
1250354-MLNS	65	1280106-MAL	73	1450014-P	78
1250356-LC2	67	1280106-MALW	73	1450018-P	78
1250450-L	67	1280106-MPL	73	1450022-P	78
1250456-L	67	1280107-MAL	73	1450024-P	78
1250456-LC	67	1280108-MAL	73	1450028-P	78
1250470-LC	67	1280108-MPL	73	1450030-P	78
1250471-LC	67	1280109-MAL	73	1450626-SSP	78
1250533	69	1280109-MALNW	74	1450630-SSP	78
1250535	69	1280110-MAL	73	1455580-NC	80
1250535-L	69	1280111-MALW	73	1457545	79
1250540	69	1280618-SS	73	1561105	88
1250540-L	69	1280624-SS	73	1561106	88
1250545-L	69	1281104-MAL	73	1561107	88
1250550	69	1282104-MPL	73	1580004	105
1250550-L	69	1300601	47	1580005	105
1250710-1DAL	74	1300601-AP	47	1580005-SS	105
1251315-06	68	1300650-L	47	1580006	105
1251415-02	68	1300709	48	1580007	105
1251415-04	68	1300709-HL1	46	1580014	104
1252140	67	1300709-L1	46	1580017	104
1253031-L	62	1300712	48	1580017-BLK	104
1253031-MNS	62	1300712-HL1	46	1580017-G	104
1253032-L	62	1300712-L1	46	1580021-BLK	104
1253032-L1	62	1300713	48	1580022	104
1255595-NC	80	1300715	48	1580022-BLK	104
1260012	69	1300715-HL1	46	1580030	103

**PART NUMBER PAGE**

1580040	104
1580045	104
1580048	104
1580074	103
1580080-AL	104
1580080-SS	104
1580082-AL	104
1580082-SS	104
1580087-AL	104
1580087-SS	104
1580095-AL	104
1580095-SS	104
1580550-BLK	105
1600003	44
1600005	44
1600008	44
1600010	44
1600205	43
1600406	43
1600409	43
1600420	41
1600607	41
1600607-L	41
1600610	43
1600611	43
1601002-L	41
1601037	42
1602016	41
1603824	42
1603825	42
1610411-A	36
1610411-EC	36
1610413-A	36
1610413-EC	36
1610413-OSS	37
1610415-A	36
1610425-A	36
1611431-A	34
1611433	34
1612401-A	33
1612402-A	33
1613401-EC	35
1613402-A	35
1614201-PP	35
1615201-EC	35
1615204-EC	35, 52
1615254-EC	34
1615431-1	33
1615433-1	33
1620001	37
1620003	37
1620004	37
1620005	37
1620016	39
1620017-S	39
1620018	37

**PART NUMBER PAGE**

1630001	38
1630001-P	38
1630003	38
1630004	38
1630401-1	33
1630402-A	36
1630402-CSS	37
1630402-EC	36
1630411-A	36
1630415-A	36
1630423-A	36
1630801-A	35
1630801-EC	35
1631037	34
1632012-A	33
1632013-A	33
1633013-A	34
1640002	58
1640007-CL	58
1640013-CL	58
1640034	108
1640036	108
1640202	56
1640203	56
1640401	57
1640403	57
1640404	57
1640425	57
1641009	55
1641019	55
1641037	56
1642005	55
1642008	55
1643013	56
1644513-S	55
1660001	97
1660003	97
1660004	96
1660012	95
1660017	97
1660018	96
1660029	95
1660029-L	95
1660030-A	97
1660032-A	97
1660230	93
1660230-BLK	93
1660231	93
1660232	93
1660232-KP1	93
1660236	93
1660701	98
1660702	98
1660703	98
1660704-L	98
1661127-CAL	99

**PART NUMBER PAGE**

1661624	99
1661624-P	99
1662127	100
1670002	91
1670002-T	91
1670002-U	91
1670006	91
1670006-GB	91
1670006-TB	91
1670006-U	91
1670008	91
1670008-TB	91
1670009	91
1670009-GB	91
1680203	56
1680411	57
1680415	57
1690001-AL1	95
1690001-SL	95
1690102	92
1690106	92
1690107	92
1690202	92
1690206	92
1690207	92
1690727-SL	94
1690901	91
1692027-L	94
1760004	106
1780010	87
1780203	109
1780223	109
1780230	110
1780233	110
1780238	110
1780240	110
1780242	110
1780245	110
1780250	111
1793313	52
1800039-T	108
1800040-T	108
1800041-T	108
1800043-T	108
1800044	108
1800044-SS	108
1800047	108
1800048	108
1800051-T	108
1800052	108
1800061-T	108
1800066-T	108
1800067-T	108
1800090	107
1800095	107
1800095-EX	107

# Part Number Index

PART NUMBER	PAGE	PART NUMBER	PAGE	PART NUMBER	PAGE
1800096	107	2100300	14	3100360	82
1800096-E	107	2100332	105	3100360-EXTL	82
1800097	107	2100340	105	3100401	82
1840021	106	2170004	105	3100460-LE1	78
1840046	109	2170095-BLK	104	3100521-1	70
1840054	106	2171000	105	3100521-CL1	70
1840220	85	2171001	105	3100521-EL1	68
1940049	90	2171003	44	3100521-L1	70
1940052	90	2171004	44	3100521-LAR1	70
1940054	90	2171008	105	3100521-LE1	70
1940057	90	2171009	105	3100521-LL1	70
2100010	59	2171032	44	3100521-LLL1	70
2100011	59	2171035	44	3100521-LS1	70
2100012	59	2171040	104	3100531-1	64
2100013	59	2171041	104	3100531-L1	64
2100025	100	2171042	104	3100531-LAR1	64
2100026	39	2171044	104	3100534-L3M	85
2100030	105	2171062	105	3100534-LSH	85
2100031	44	2171072	105	3100534-S	85
2100032	39	3042045	103	3100537-L3	85
2100033	105	3042045-SS	103	3100544-E1	83
2100034	105	3042048	103	3100545	83
2100038	59	3100007	86	3100545-EW	83
2100040	59	3100009	86	3100548	85
2100055	39	3100015-1	87	3100550-L	87
2100055-M	39	3100018	86	3100550-SS	78
2100067	111	3100018-O1L	86	3100565-L	76
2100073	111	3100019	86	3100565-LA	76
2100074	111	3100021-1	70, 99	3100565-LAR	76
2100075	111	3100021-CR1	70	3100565-LARA	76
2100077	39	3100021-L1	50, 70	3100565-LARW	76
2100079	111	3100021-LAR1	70	3100565-LW	76
2100091	59	3100031-1	42, 47, 52, 64	3100575-L	77
2100091-B	59	3100031-L1	42, 47, 64	3100575-LAR	77
2100092	53, 100	3100031-LAR1	64	3100575-LARW	77
2100092-B	53, 100	3100034	84	3100645-S	83
2100093	100	3100036	84	3100646	83
2100093-B	100	3100036-BLK	84	3100647	83
2100094	39	3100037	84	3100656	83
2100095	105	3100038-BLK	84	3100656-01	77
2100096	105	3100039	84	3100661-M	83
2100097	87	3100047-BLK	83	3100665-01	83, 85
2100099	105	3100050	87	3100675-L	77
2100104	100	3100050-L	87	3100676-L	77
2100115	100	3100065-L	76	3100676-LARS	77
2100145	90	3100065-L2	76	3100676-LS	77
2100146	90	3100075-L	77	3100930-A1	71
2100147	90	3100075-LAR	77	3100930-A1N	74
2100148	90	3100075-LB	77	3100931	71
2100149	90	3100205	85	3101521-L	71
2100151	90	3100205-M	85	3101521-LAR	71
2100175	39	3100207	84	3101521-LARW	71
2100184	90	3100300	83	3101521-LE	68
2100194	90	3100300-SM	83	3101521-LW	71
2100196	19	3100318	86	3101545-EW	83
2100272-RTS	106	3100319	86	3300601	47

PART NUMBER	PAGE	PART NUMBER	PAGE	PART NUMBER	PAGE
3300601-AP	47	3600008	44	3630020-NB	38
3300709	48	3600010	44	3630020-OS	38
3300709-HL	48	3600406	43	3630020-OSNB	38
3300710	48	3600409	43	3630024	39
3300712	48	3600413	43	3630025	39
3300712-HL	48	3600610	43	3630402-A	36
3300713	48	3600610-LD	43	3630402-CSS	37
3300713-HL	48	3601002	41	3630402-EC	36
3300714	48	3601002-L	41	3630402-P	36
3300715	48	3603825-NS	42	3630409-P	36
3300715-HL	48	3610411-A	36	3630411-A	36
3300728	48	3610411-EC	36	3630413-SS	36
3300728-HL	48	3610411-P	36	3630414-A	36
3300750-1	49	3610413-A	36	3630423-A	36
3300750-A1	49	3610413-EC	36	3630423-P	36
3300750-AD1	49	3610413-OSS	37	3630801-A	35
3300750-AL1	49	3610413-P	36	3630801-EC	35
3300750-AR1	49	3610413-PSS	36	3632012-A	33
3300750-D1	49	3610415-A	36	3632012-EC	33
3300750-L1	49	3610415-P	36	3632013-A	33
3300750-R1	49	3610425-A	36	3632013-EC	33
3300751-1	49	3612401-A	33	3633011-SSA	34
3300752-D	49	3612402-A	33	3633013-A	34
3300753-1	49	3613401-EC	35	3633013-SSA	34
3300753-K1	49	3613402-A	35	3640002	58
3300754-1	49	3614201-PP	35	3640002-CLA	58
3300757-D1	49	3614204-PP	35	3640007-CL	58
3300758-1	49	3615201-EC	35	3640012-CL	58
3300759-PP1	49	3615204-EC	35, 52	3640012-PASSCL	58
3300760	50	3615207-ECB	35	3640013-CL	58
3300764-PP1	49	3615207-SSECB	35	3640021-CL	58
3300766	50	3615254-EC	34	3640022-PPCL	58
3300850-A1	50	3620001	37	3640023	59
3300900	46	3620001-P	37	3640024-CL	58
3300901	46	3620003	37	3640025-CL	58
3300902-AS	46	3620004	37	3640028-CL	58
3301809	50	3620005	37	3640032-PP	108
3301812	50	3620005-P	37	3640033-PPPT	93
3301818	50	3620011	37	3640034	108
3310708-L	48	3620016	39	3640035	108
3310709-L	48	3620017-SB	39	3640035-S	108
3310710-L	48	3620018	37	3640036	108
3310712-L	48	3620024	39	3640038	108
3310715-L	48	3620025	39	3640040	108
3310725-L	48	3620760	39	3640045-S	108
3312701	47	3630001	38	3640047-S	108
3312701-PP	47	3630001-PB	38	3640202	56
3580004	105	3630003	38	3640203	56
3580005	105	3630004	38	3640401	57
3580006	105	3630004-BLK	38	3640411	57
3580007	105	3630004-EC	38	3640413	57
3580012-A	105	3630005	38	3640415	57
3580012-P	105	3630005-PB	38	3640511-A	57
3600002-AB	44	3630007-NB	38	3640513-A	57
3600003	44	3630019	38	3641007	55
3600005	44	3630020	38	3641013	55

# Part Number Index

PART NUMBER	PAGE	PART NUMBER	PAGE	PART NUMBER	PAGE
3641507	55	3662027	100	3692029-L	94
3641508-AS	55	3662027-P	100	3692700	95
3642507-BAS	55	3662030	100	3760004	106
3660002	97	3662031	100	3760022	109
3660003	97	3663027	100	3760025	109
3660004	96	3663030	100	3760027	109
3660004-SM	96	3664230-RV	99	3760040	91
3660017	97	3664250-RV	99	3760060	103
3660017-BLK	97	3664275-RV	99	3760060-ND	103
3660018	93, 96	3664300-RV	99	3760063-ST	103
3660023	96	3670702	93	3760710-P	93
3660024-A	97	3670703	93	3780238	110
3660026-A	97	3680012-CL	59	3780245-01	110
3660026-P	97	3680012-PASSCL	59	3780245-02	110
3660030-A	97	3680013-CL	59	3780278	110
3660032-A	97	3680038-CL	59	3780425-03	110
3660032-P	97	3680203	56	3793012-A	53
3660037-A	97	3680411	57	3793013-A	53
3660107	99	3680415	57	3793211	53
3660127-CAL	99	3690001	95	3796010-AL	53
3660127-CPL	99	3690001-AL	95	3796010-PL	53
3660207	99	3690001-BLKL	95	3796010-SL	53
3660324	97	3690001-SL	95	3820008	106
3660325	97	3690007	100	3840020	106
3660327	97	3690007-A	100	3840021	106
3660328	97	3690007-P	100	3840054	106
3660334	97	3690007-SS	100	3840054-CS	106
3660525	96	3691014-L	94	3840054-NH	106
3660527	96	3691025-L	94	3840220	85
3660619	97	3691027	94	5191131	71
3660703	98	3691027-L	94	7100170	91, 100
3660704-L	98	3691028-L	94	8123050	106
3660727	98	3692027-L	94	8123052	106
3660900	93	3692027-LU	94	8123060	106

The entire content of this catalog, including but not limited to images, text, code, materials and other components or elements herein are copyrighted materials owned by Springfield Marine or other third parties, and are protected by United States, worldwide copyright and trademark laws and treaty provisions. Therefore, you may not use, copy, reproduce, publish, modify, transmit, upload or distribute the contents or elements of this catalog in any way without Springfield Marine's express prior written permission. This catalog may be used for informational purposes, online ordering of products, creating and accessing Springfield Marine's user accounts; but, may not be used to commercialize or market any product or service without our express written permission. Permission is granted to electronically copy and print hard copy portions of this catalog for the sole purpose of placing an order with the Springfield Marine website and/or user account; thus, solely for your own non-commercial use. Except as expressly provided herein, Springfield Marine does not grant to users or individuals who access this catalog any express or implied rights under any patents, copyright, trademarks, or trade secrets. Copy of any portion of this catalog thereof must be maintained in an unchanged fashion, include the copyright notices as it appears on this catalog.

All rights are hereby expressly reserved.

 [www.springfieldgrp.com](http://www.springfieldgrp.com) 

Kingpin™

Taper-Lock™

Plug-In™

Thread-Lock™

Spring-Lock™

Accessories

## SPRINGFIELD MARINE'S

### Color Coding System

Our Color-Coded Packaging System simplifies your search for the right item to fit your boat. Simply match the parts according to the color of your product series to ensure proper fit.



# Springfield Marine Company

is a proud member of these associations and subscribes to the standards and practices which they set forth.



## About ABYC H-31 Classifications And Safety Standards

The American Boat and Yacht Council (ABYC) has recommended marine industry seating standards for pedestal applications into two separate categories as follows:

- Class A** Seat designed for occupancy while the boat is underway at any speed.
- Class B** Seat designed for occupancy only at boat speeds not exceeding five miles per hour (fishing or trolling).

All pedestals must pass a series of tests within each of these classifications which include horizontal and vertical impacts, torque, static load, fatigue, and fastener pull testing.

There are two types of class A seats:

- Class AP - Passenger** Seat mount must resist 30 foot pounds of torque (non-locking).
- Class AD - Driver** Seat mount must incorporate a "mechanical interference lock" and resist 150 foot pounds of torque (locking).

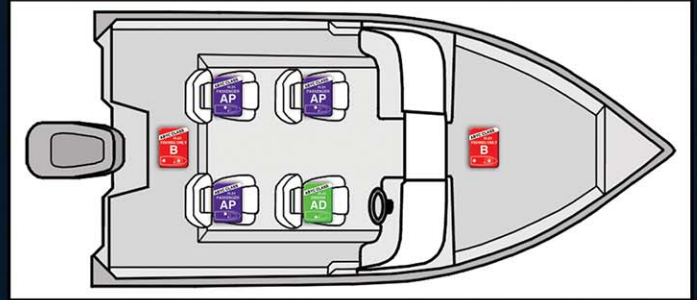

CLASS B



CLASS AP



CLASS AD

Look for these labels to identify the ABYC H-31 Classifications

Springfield Marine Company has been a leader in establishing and complying with these ABYC recommended standards.

IN ORDER TO COMPLY WITH THESE STANDARDS, SPRINGFIELD COMPONENTS MUST BE COMBINED WITH OTHER SPRINGFIELD PARTS. MIXING SPRINGFIELD PARTS WITH NON-SPRINGFIELD COMPONENTS VOIDS THESE STANDARD CLASSIFICATIONS.

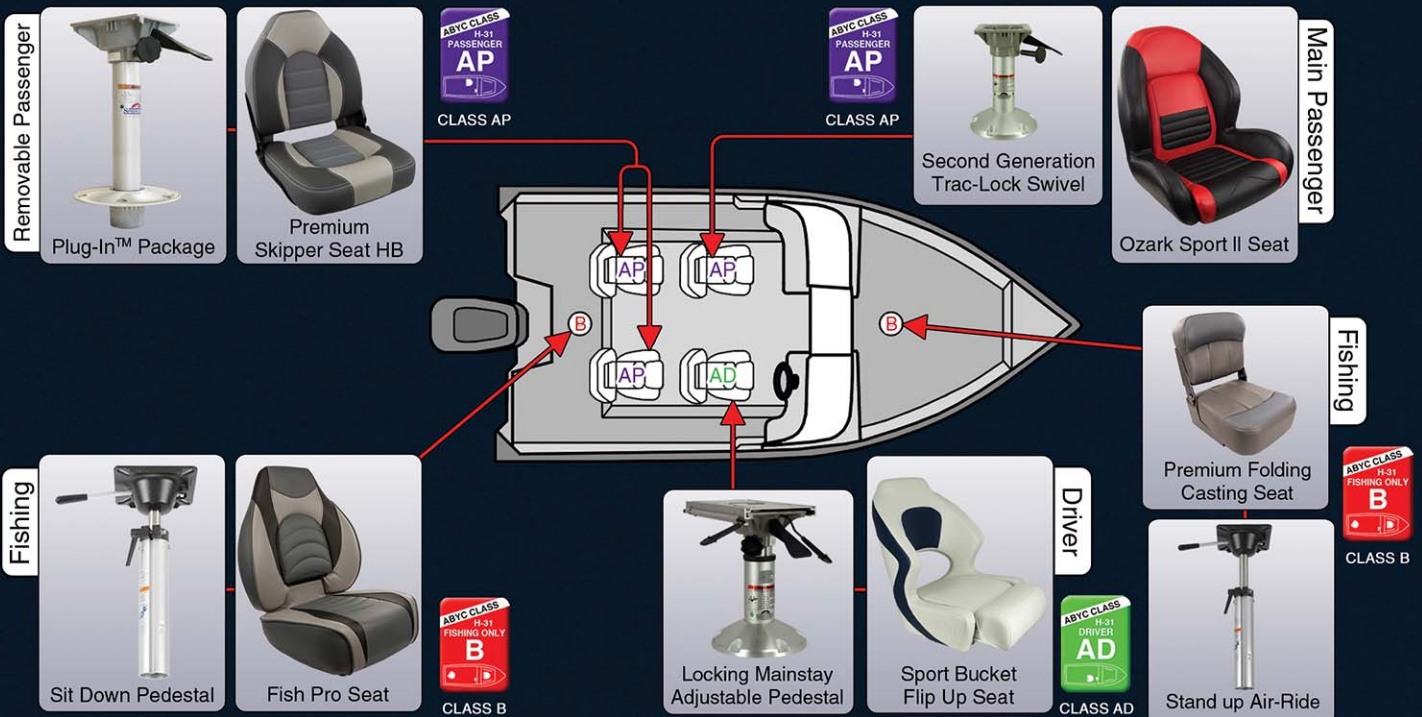

**ABYC H-31**

Example of multiple parts on typical model boat



SPRINGFIELD MARINE COMPANY

# YOUR SEATING SOLUTION



1093 N. CYNTHIA DRIVE SUITE 1 NIXA, MO 65714  
PHONE: (417) 725-2667 | FAX: (417) 724-9035  
EMAIL: [sales@springfieldgrp.com](mailto:sales@springfieldgrp.com)  
[www.springfieldgrp.com](http://www.springfieldgrp.com)