

ignition switches

A



- 95060 Series A1
- All-Purpose Ignition Switches A2
- Specialized Ignition Switches A3
- Accessories A4

A1 SEALED KEY SWITCH SERIES 95060

Sealed Key Switch Series 95060

Fully sealed to IP-67, (immersible) these switches are ruggedly constructed from engineering thermoplastic, with an integral Deutsch connector. Suitable for use as rotary switches as well as for ignition.



Tested to SAE J259 for ignition switches. Plastic facenut and nickel-plated brass backing nut. Supplied with two matching double bitted keys, with or without TPE (thermoplastic elastomer) key boot. Mounting stem M22 x 1.5 is 0.85" long (21.6mm) and 0.87" diameter (22.0mm). Double-D mounting hole is 22.5mm diameter with two flat sides at 9.75mm from the center. Maximum panel thickness 8mm. For replacement keys see page 5. 10A at 12V DC, 5A at 24V DC.

Clamshell retail units 95060-50BP and 95060-60BP contain switch and wire harness (wires and Deutsch connector.) 95060-50BP contains switch 95060; 95060-60BP contains switch 95060-03. Wire colors conform to ABYC specifications.



Four Position Switches

Part Number	Positions	Spring Return	With Key boot	Keyed alike?
95060	Acc-Off-Run-Start	Yes	Yes	No
95060-01	Acc-Off-Run-Start Anti-restart	Yes	Yes	No
95060-02	Acc-Off-Run-Start	No	Yes	No

Three Position Switches

Part Number	Positions	Spring Return	With Key boot	Keyed alike?
95060-03	Off-Run-Start	Yes	Yes	No
95060-04	Off-Run-Start Anti-restart	Yes	Yes	No
95060-05	Off-Run-Start	No	Yes	No
95060-06	Acc-Off-Run (no Start)	N/A	Yes	No

Two Position Switches

Part Number	Positions	Spring Return	With Key boot	Keyed alike?
95060-07	Off-Run	N/A	Yes	No

Anti-Restart Switches

Part Number	Positions	Spring Return	With Key boot	Keyed alike?
95060-01	4-Position Acc-Off-Run-Start	Yes	Yes	No
95060-04	3-Position Off-Run-Start	Yes	Yes	No

Twin Engine Boats We recommend anti-restart switches for use in noisy situations, especially for twin engine boats where the operator might be unaware that an engine is already running.

★ Rapid ship item. BP Available in retail clamshell pack. ★ Minimum order quantity may apply. Part numbers needed in BOX require a -BX suffix on the purchase order.

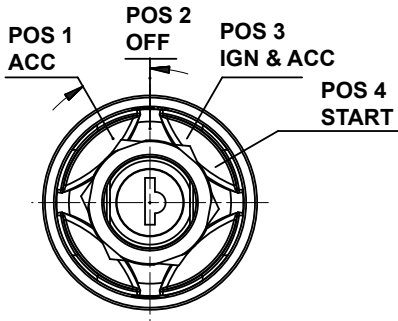

	Battery Terminals 1 & 6	Start Terminal 2	Accessory Terminal 3	Ignition Terminals 4 & 5
Position 1	X		X	
Position 2	X			
Position 3	X		X	X
Position 4	X	X		X

Keys for 95060 series switches - see page 5.

M-712-02 Weather-Resistant

Same as M-712, except with O-ring seal in the mounting stem, and with spring-actuated shutter in the lock face to protect the cylinder when not in use.

M-712-09 With Rubber Boot Assembly BP

Same as M-712, except with weather-resistant rubber boot and mounting nut assembly to protect against moisture and dirt with or without the key inserted.



M-700 With Diecast Case

Four brass screw terminals. Diecast case with protective finish. Mounting stem 3/4" -20, 13/16" (20.6mm) long, fits panels up to 1/4" (6.4mm). Knurled aluminum adapter facenut permits mounting in 3/4" (19.1mm) to 7/8" (22.2mm) diameter holes.



M-95502

Same as M-700, but with blade terminals.

A2 ALL-PURPOSE IGNITION SWITCHES

Suitable for harsh environments whether on land or at sea. They are corrosion-resistant, often with brass cases and extra seals. Moisture-repellent insulators, coded locks with 2 brass keys. For 6-36V DC applications.

4-Position

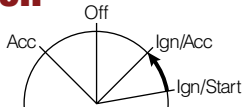

Key is removable only in the Off position, spring return to IGN/ACC. Electrical ratings at 12V DC: 10A Accessory, 5A Ignition, 5A Start. **See also 95060 Series switches on page 1.**

M-712 BP ★

Four brass screw terminals. Brass case and mounting hardware, chrome-plated brass facenut. Brass mounting stem 13/16" -24, 1 7/32" (31.0mm) long, fits panels up to 1" (25.4mm).



3-Position

Off – Ignition – Ignition/Start

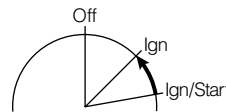

Key is removable only in the Off position, spring return to IGN. Electrical ratings at 12V DC: 10A Ignition, 5A Start. **See also 95060 Series switches on page 1.**

M-550 With Screw Terminals BP ★

Three brass screw terminals. Brass case and mounting hardware, chrome-plated brass facenut. Brass mounting stem 13/16" -24, 1 7/32" (31.0mm) long, fits panels up to 1" (25.4mm).



★ Rapid ship item. BP Available in retail clamshell pack. ★ Minimum order quantity may apply. Part numbers needed in BOX require a -BX suffix on the purchase order.

M-550-14 With Rubber Boot Assembly BP

Same as M-550, except with weather-resistant rubber boot and mounting nut assembly to protect against moisture and dirt with or without the key inserted.

**M-550-25 With Protective Cap**

Same as M-550, except with a captive plastic cap that snaps over a special facenut to protect the lock when not in use. Fits panels up to 5/8" (15.9mm).

**M-6110-01 Weather-Resistant**

Same as M-550, except with O-ring seal in the mounting stem, and with spring-actuated shutter in the lock face to protect the cylinder when not in use.

M-711 With Diecast Case

Three brass screw terminals. Diecast case with protective finish. Mounting stem 3/4" -20, 13/16" (20.6mm) long, fits panels up to 1/4" (6.4mm). Knurled aluminum adapter facenut permits mounting in 3/4" (19.1mm) to 7/8" (22.2mm) diameter holes.

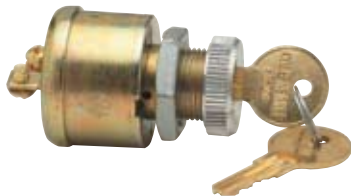
**M-850 Plastic Body** BP ★

Key is removable only in the Off position, spring return to IGN. Electrical ratings at 6-36V DC: 15A Ignition, 5A Start. Three nickel-silver screw terminals. Durable plastic case and stem with PVC boot for added weather protection. Mounting stem fits panels up to 7/8" (22.2mm) thick, with 7/8" diameter hole. Fits many boats, including Baja, Celebrity, Chapparral, ChrisCraft, Crestliner, Crownline, Four Winns, Larson, Luhrs, Mariah, Powerquest, Rinker, S2 Yachts, Silverton Yacht, Thompson, Thunderbird (Formula), Wellcraft.

**With Push-To-Choke****M-832 Plastic Body** BP ★

Key is removable only in the Off position, spring return to IGN. Electrical ratings at 6-36V DC: 15A Ignition, 5A Start. Six nickel-silver screw terminals. Durable plastic case and stem with PVC boot for added weather protection. Long mounting stem 2.00" (50.8mm) long, fits panels up to 1 3/8" (34.9mm) thick, and with 7/8" diameter hole (22.2mm) Fits many boats, including Bayliner, ChrisCraft, Sea Ray.

**M-932**

Key is removable only in the Off position, spring return to IGN. Electrical ratings at 12V DC: 5A Ignition, 5A Start, 2A Choke.

One brass screw and three brass blade terminals. Brass case and mounting hardware, chrome-plated brass facenut. Brass mounting stem 13/16" -24, 15/16" (23.8mm) long, fits panels up to 1/2" (12.7mm). O-ring seal in the mounting stem.

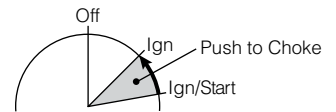
**Custom Keys**

We made this elegant key to grace the keyrings of Cobalt boat owners. The keys will start their beautiful boats using reliable Cole Hersee ignition switches.

Whether you want a glossy or embossed logo key, we can do that. Ask us!

2-Position

Key is removable only in the Off position.

M-489 BP ★

Electrical ratings at 12V DC: 10A Ignition. Two brass screw terminals. Brass case and mounting hardware, chrome-plated brass facenut. Brass mounting stem 13/16" -24, 1 7/32" (31.0mm) long, fits panels up to 1" (25.4mm).

See also 95060-07 on page 1.



M-489-03 Weather-Resistant

Electrical ratings at 12V DC: 10A Ignition. Same as M-489, except with O-ring seal in the mounting stem, and with spring-actuated shutter in the lock face to protect the cylinder when not in use.

M-497 With Lever BP ★

Electrical ratings at 12V DC: 10A Ignition. Two brass screw terminals. Brass case, brass mounting stem 1/2" -20, 1 1/4" (31.8mm) long, fits panels up to 7/8" (22.2mm). chrome-plated diecast long lever.



M-702 With Diecast Case

Electrical ratings at 12V DC: 10A Ignition. Two brass screw terminals. Diecast case with protective finish. Mounting stem 3/4" -20, 13/16" (20.6mm) long, fits panels up to 1/4" (6.4mm). Knurled aluminum adapter facenut permits mounting in 3/4" (19.1mm) to 7/8" (22.2mm) diameter holes.



M-676 BP ★

Electrical ratings at 12V DC: 5A Ignition. Two brass screw terminals. Brass case with chrome-plated integral bezel. Brass mounting stem 3/4" -27, 3/4" (19.1mm) long, fits panels up to 5/8" (15.9mm). Double bit keys.



A3 SPECIALIZED IGNITION SWITCHES

Diesel Ignition and Start Switches

These heavy-duty switches provide a superior pre-heat circuit to energize the glow plugs.

956-9100

4-Position

Key removable at Off, spring return to IGN/ACC, spring return from FUEL. Electrical Ratings at 12V DC: 10A Fuel, 10A Accessory, 5A Ignition, 5A start. Five screw terminals. Diecast case. 1" -24 mounting stem, with O-ring seal, fits panels up to 3/32" (2.4mm). Gasket-sealed terminal insulator. Hencol key is 83357.

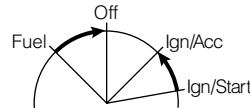

95033

3-Position

Spring return to Off. Electrical Ratings at 12V DC: 50A Glow Plug, 10A Start. Three screw terminals. Plated steel case. 5/8" -32 mounting stem, with O-ring seal, fits panels up to 1/4" (6.7mm). Silver contacts.

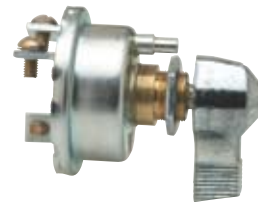
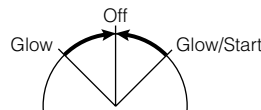

Push-Pull Ignition & Start Switch

9576

Spring return to IGN/ACC. Electrical Ratings at 12V DC: 10A Accessory, 5A Ignition, 5A Start. Four screw terminals. Plated steel case. 3/8" -24 mounting stem fit panels up to 3/16" (4.8mm). Includes hexnut and washer for mounting. Black plastic screw-on knob.

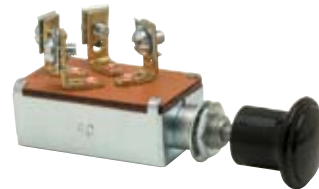

Off Ign/ACC Ign/Start



2-Circuit Switches

M-703

Key removable in both positions. Electrical ratings at 12V DC: 10A both positions. Three brass screw terminals. Diecast case. Mounting stem 3/4" -20, 13/16" (20.6mm) long, fits panels up to 1/4" (6.4mm). Knurled aluminum adapter facenut permits mounting in 3/4" (19.1mm) to 7/8" (22.2mm) diameter holes.

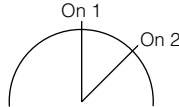

Magneto Ignition & Start Switch

95520-B 70A Start

Electrical ratings at 12V DC: 70A Start, 1A Magneto. Three screw terminals. Plated steel case. 5/8" -32 mounting stem with O-ring seal, fits panels up to 1/4" (6.4mm). Long Hencol key number 83353.

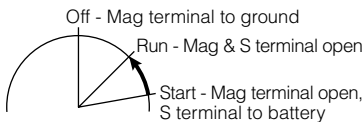

Key removable in Off position, spring return to RUN. Self-grounding in the Off position in metal panels.

M-924 With Push-To-Choke

Marine 3-position magneto ignition and battery start switch. Key removable in Off position, spring return to RUN. Electrical ratings at 12V DC: 2A Magneto, 10A Battery/Ignition, 3A Choke, 5A Start. Six brass screw terminals. Brass case and mounting hardware, chrome-plated brass facenut. Brass mounting stem 13/16" -24, fits panels up to 15/16" (23.8mm). O-ring seal in the mounting stem.

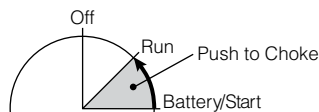
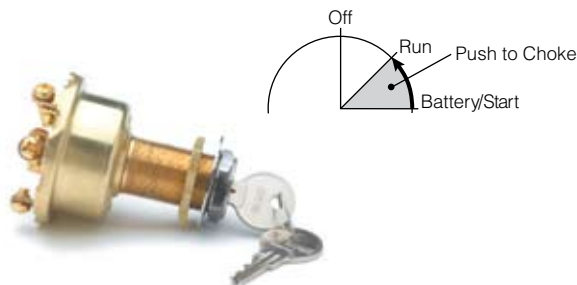

A4 ACCESSORIES

Protective Boots

Mounting nut containing a durable rubber disk with a self-closing key slot.

83285-01 Aluminum ★

3/4" -20 thread, 7/16" (11.1mm) thickness.



83288 Chrome-Plated Brass BP ★

13/16" -24 thread, 17/32" (13.5mm) thickness.



Plastic Cap

97298

Captive black protective cap, used with facenut 83295-A



Keys for Cole Hersee Ignition Switches

83379

For most keyed ignition switches in this catalog except 95060 series and 95520-B.



Keys for 95060 Ignition Switch

Key entryway on the switch and its matching key are stamped with a three-digit code. Order the part number that matches the code, or use the blank key to make a copy of your key.

Keycode	Part Number
Blank key	83451-1
601	83451-601
602	83451-602
603	83451-603
604	83451-604
605	83451-605
701	83451-701
702	83451-702
703	83451-703
704	83451-704
705	83451-705



Find The Right Ignition Switch

Part Number	Description	Case	Bushing	Sealing	Anti-restart
4-position					
956-9100	Glow-Acc-Run-Start. Mom start	Diecast	1	O-Ring seal in bushing and gasket seal in base	No
95060	Acc-Off-Run-Start. Mom start	Plastic	M22x 1.5	Fully sealed to IP67	No
95060-01	Acc-Off-Run-Start. Mom start	Plastic	M22x 1.5	Fully sealed to IP67	Yes
95060-02	Acc-Off-Run-Start. Stable start	Plastic	M22x 1.5	Fully sealed to IP67	No
95060-50BP	Acc-Off-Run-Start. Mom start	Plastic	M22x 1.5	Fully sealed to IP67	No
M-700	Acc-Off-Run-Start. Mom start	Diecast	3/4	None	No
M-712	Acc-Off-Run-Start. Mom start	Brass	13/16	None	No
M-712-02	Acc-Off-Run-Start. Mom start	Brass	13/16	O-Ring seal in bushing	No
M-712-09	Acc-Off-Run-Start. Mom start	Brass	13/16	Boot in Face Nut	No
M-95502	Acc-Off-Run-Start. Mom start	Diecast	3/4	None	No
3-position					
95033	Mom On-Off-Mom On. (Glow-Off-Start)	Plated Steel	5/8	O-Ring seal in bushing and Hencol seal in base	No
95060-03	Off-Run-Start. Mom start	Plastic	M22x 1.5	Fully sealed to IP67	No
95060-04	Off-Run-Start. Mom start	Plastic	M22x 1.5	Fully sealed to IP67	Yes
95060-05	Off-Run-Start. Stable Start	Plastic	M22x 1.5	Fully sealed to IP67	No
95060-06	Acc-Off-Run. NO Start	Plastic	M22x 1.5	Fully sealed to IP67	No
95060-60BP	Off-Run-Start. Mom start	Plastic	M22x 1.5	Fully sealed to IP67	No
M-550	Off-Run-Start. Mom start	Brass	13/16	None	No
M-550-14	Off-Run-Start. Mom start	Brass	13/16	Boot in face nut	No
M-550-25	Off-Run-Start. Mom start	Brass	13/16	Protective Cap	No
M-711	Off-Run-Start. Mom start	Diecast	3/4	None	No
M-832	Magneto. Off-Run-Start. Mom start	Plastic	13/16	O-Ring seal in bushing	No
M-850	Off-Run-Start. Mom start	Plastic	13/16	O-Ring seal in bushing	No
M-924	Magneto. Off-Run-Start. Mom start	Brass	13/16	O-Ring seal in bushing	No
M-932	Off-Run-Start. Mom start	Brass	13/16	O-Ring seal in bushing	No
M-6110-01	Off-Run-Start. Mom start	Brass	13/16	O-Ring seal in bushing	No
95520-B	Magneto. Off-Run-Start, Mom Start	Plated Steel	5/8	O-Ring seal in bushing	No
2-position					
95060-07	Off-Run	Plastic	M22x 1.5	Fully sealed to IP67	No
M-489	Off-Run	Brass	13/16	None	No
M-489-03	Off-Run	Brass	13/16	O-Ring seal in bushing, and shutter	No
M-497	Off-Run	Brass	1/2	None	No
M-676	Off-Run	Plated Steel	3/4	None	No
M-702	Off-Run	Diecast	3/4	None	No
M-703	On 1-On 2	Plated Steel	3/4	None	No

★ Rapid ship item. **BP** Available in retail clamshell pack. ★ Minimum order quantity may apply. Part numbers needed in BOX require a -BX suffix on the purchase order.

Code Type	Key Code	Actuator	Key Blank	Other Info
4-position				
Keyed Alike	N/A	Short Hencol	83357	Diesel start circuit with momentary glow plug position
Mixed	CH600-CH799	Metal Key with Boot	83451-1	
Mixed	CH600-CH799	Metal Key with Boot	83451-1	
Mixed	CH600-CH799	Metal Key with Boot	83451-1	
Mixed	CH600-CH799	Metal Key with Boot	83451-1	Kit 95060 with connector and pigail harness
Mixed	250 Combinations	Metal Key	83379	
10 Codes	CH500-CH523	Metal Key	83379	Loose Hardware
10 Codes	CH500-CH523	Metal Key	83379	
10 Codes	CH500-CH523	Metal Key	83379	
10 Codes	CH500-CH523	Metal Key	83379	Blade Terminals
3-position				
N/A	N/A	Long Lever		
Mixed	CH600-CH799	Metal Key with Boot	83451-1	
Mixed	CH600-CH799	Metal Key with Boot	83451-1	
Mixed	CH600-CH799	Metal Key with Boot	83451-1	
Mixed	CH600-CH799	Metal Key with Boot	83451-1	
Mixed	CH600-CH799	Metal Key with Boot	83451-1	
10 Codes	CH500-CH523	Metal Key	83379	No Acc terminal
Mixed	CH500-CH523	Metal Key	83379	No Acc terminal
10 Codes	CH500-CH523	Metal Key	83379	Snapcap.No Acc terminal
Mixed	250 Combinations	Metal Key	83379	No Acc terminal
5 Codes		Metal Key		Push-to-choke
5 Codes		Metal Key		Push-to-choke
12 Codes	CH500-CH523	Metal Key	83379	Push-to-choke
7 Codes	CH500-CH523	Metal Key	83379	Push-to-choke
10 Codes	CH500-CH523	Metal Key		No Acc terminal
Keyed Alike	CH500-CH523	Metal Key		No Acc terminal
2-position				
Mixed	CH600-CH799	Metal Key with Boot	83451-1	
10 Codes	CH500-CH523	Metal Key	83379	Long Neck
10 Codes	CH500-CH523	Metal Key	83379	Long Neck
N/A	N/A	Long Lever		
Mixed	250 Combinations	Metal Key		
Mixed	250 Combinations	Metal Key	83379	
Mixed		Metal Key	83379	Key removable in both positions

★ Rapid ship item. **BP** Available in retail clamshell pack. ★ Minimum order quantity may apply. Part numbers needed in BOX require a -BX suffix on the purchase order.



Find The Right Switch

Function	Switch Type	Rocker Switch	Toggle Switch
General On-Off	SPST On-Off	56027-01, 58027-01, 58311-01, M-58031-01	5520, 5582, 5582-10, 5582-30, 55014, 55014-05, 55023, 55055, 55055-01, 54100, 54100-01, M-484, M-493, M-584, M-586
General On-Off	SPST On-Off, illuminated	54003, 54003-01, 54012, 56327-01, 58312-A2, 58312-R2, 58312-C4, 58312-G2, 58312-G4, 58312-A4, 58312-R4, 58312-GA4, 58312-RG4, 58312-RR4, 58327-01, 58328-01, 58328-02, 58328-04, 58328-10, 58328-11, 58328-12, 58328-13, 58328-40, 58328-47, 58328-49, 58328-100, 58328-101, 58328-104	54109, 54109-01, M-54111-01
Horn	SPST Mom On-Off	58027-02, 58311-02, 58332-20, M-58031-07	55020, 55020-04, 55037, 55049-01, 55052-01, 54101, 54101-01
2 Tank Fuel Gauge	SPDT On-On	54010	
Single Wiper	SPDT Mom On-Off-On	58332-23	55088
Lighting	SPDT On-Off-On	M-58031-02, 56000-03, 57003-16, 54001-02	54103, 54103-01, 5586, 55016, 55016-06, 55036, 55036-14
Lighting	DPST On-Off	58027-06, 58311-06, M-58031-04	54105, 54105-01,
Lighting	DPST On-Off, illuminated	58332-29	
Trim Tabs or Windlass	SPDT Mom On-Off-Mom On	58027-04, 58311-04, 58332-22, 58332-24	54104, 54104-01
Bilge Pump	SPDT On-On, illuminated	58312-RG2, 58312-RR2, 58327-06, 58328-08, 58328-16, 58328-22, 58328-102	
Bilge Pump	SPDT On-Off-On, illuminated	58312-RC, 58312-RR, 58312-AG, 58312-AR, 58312-RG, 58327-06, 58332-21, 58328-06, 58328-25, 58328-26, 58328-33, 58328-35, 58328-36, 58328-103	54110, 54110-01, M-54111-02
Courtesy Lights	DPST Mom On-Off	58332-28	
	DPDT On-On	58027-08, 58311-08, M-58031-06	
	DPDT On-Off-On	58027-07, 58311-07, 58311-11, M-58031-05	54107, 54107-01
Trim Tab, Windlass	SPDT Mom On-Off - Mom On	M-58031-08, 56012-04, 57004-10, 58332-22, 58332-24	54104, 54104-01, 55021, 55021-04, 55021-07, 55021-08, 55033-01, 55033-02
Trim Tabs	DPDT On-Off-On, illuminated	58332-26	
Windlass	DPDT Mom On-Off-On	58027-11, 58332-27, M-58031-09	
Wiper with Mist	DPDT Mom On-Off-On, illuminated	58332-25	
Ignition/Start	DPDT Mom On-On-Off	58022-03, 58311-13	59071, 55094
Reversing	DPDT Mom On-Off-Mom On	58027-18, 58311-18	55046-06
2-Speed Heater Fan	DPDT		55093
Emergency Cutoff			M-597
Locking Switch	SPST On-Off	58336	

★ Rapid ship item. **BP** Available in retail clamshell pack. ★ Minimum order quantity may apply. Part numbers needed in BOX require a -BX suffix on the purchase order.